

---

# KIWI/CLOVER AGRICULTURE SENSOR



## USER GUIDE

---

**Document Number:** T0005978\_UG

**Document Issue:** 2.2

**Issue Date:** June 28, 2024

---

**PROPRIETARY:**

The information contained in this document is the property of TEKTELIC Communications Inc. Except as specifically authorized in writing by TEKTELIC, the holder of this document shall keep all information contained herein confidential, and shall protect the same in whole or in part from disclosure to all third parties.

© 2024 TEKTELIC Communications Inc., all rights reserved.

All products, names, and services are trademarks and registered trademarks of their respective companies.

## Table of Contents

1	Product Description .....	4
1.1	Overview .....	4
1.2	Specifications.....	5
2	Installation .....	8
2.1	Included Product and Installation Material .....	8
2.2	Safety Precautions.....	8
2.3	Unpacking and Inspection .....	8
2.4	Equipment Required for Installation.....	9
2.5	Commissioning .....	9
2.6	Reed Switch Awakening Procedure .....	9
2.7	KIWI Sensor Mounting .....	11
2.8	Cable Installation.....	11
2.9	Default Configuration.....	13
2.9.1	Default Configuration for CLOVER .....	13
2.9.2	Default Configuration for KIWI .....	13
2.10	Reconfiguration.....	14
2.11	LED Behaviour .....	14
2.12	Battery Replacement.....	15
3	Agriculture Sensors Types Functions.....	16
3.1	CLOWER Enclosure .....	16
3.2	KIWI Enclosure .....	17
3.2.1	Physical Interfaces – KIWI Only.....	18
3.2.2	Analog Thermistors – Inputs 3 and 4 .....	19
3.2.3	One wire probes - Inputs 3 and 4 .....	20
3.2.4	Watermark Probes - Inputs 5 and 6.....	21
4	Basic Downlinks .....	23
5	Device Configuration with ATLAS .....	25
6	Data converters .....	28

7	Troubleshooting.....	29
8	Compliance Statements.....	30

# 1 Product Description

## 1.1 Overview

The Agricultural Sensor is a multi-purpose LoRaWAN IoT sensor intended for Agricultural use with two possible models:

- “KIWI” model supports the connection of up to four analog and two digital probe inputs, allowing for remote capture of data
- “CLOVER” model includes two integrated metal probes for contact measurement of soil data

Table 1 presents the Agriculture Sensor models and their corresponding RF information.

**Table 1: Agriculture LoRa IoT Sensor Models**

Product Code & Revision	Description	RF Region	Tx Band (MHz)	Rx Band (MHz)
<b>T0005986</b>	AGRICULTURE SENSOR, KIWI MODULE	US 902-928 MHz (ISM Band) EU 863-870 MHz (ISM Band)	923-928 863-870	902-915 863-870
<b>T0005982</b>	AGRICULTURE SENSOR, SOIL CLOVER MODULE	US 902-928 MHz (ISM Band) EU 863-870 MHz (ISM Band)	923-928 863-870	902-915 863-870

The main features of the Agricultural Sensor are listed below:

- **Temperature & Relative Humidity Sensor:** Reports temperature and relative humidity of the ambient environment.

**NOTE:** placing the unit in direct sunlight will result in the sensor reporting case temperature and relative humidity instead of true ambient conditions. Place the unit out of the sun for more accurate ambient temperature and relative humidity readings.

- **Accelerometer:** High-sensitivity device that can measure any shock or movement events. The primary purpose is to detect orientation change and report orientation change alarm.
- **Light Sensor:** reports the ambient light intensity measured in units of lux. Please review ambient light measurement application notes here: [2150\\_RRH\\_SDS \(hubspotusercontent-na1.net\)](https://hubspotusercontent-na1.net)
- **Current Sense:** provides accurate battery life estimation in percentage and days remaining.

- **Analog thermistor and One wire probe – KIWI only:** Option to measure temperature using external probes interfaced with the sensor.
- **Watermark Sensor – KIWI only:** Option to receive data on soil water tension. The Watermark is a resistive device that responds to changes in soil moisture. Once planted in the soil, it exchanges water with the surrounding soil thus staying in equilibrium. Soil water is an electrical conductor thereby providing a relative indication of the soil moisture status. As the soil dries, water is removed from the sensor and the resistance measurement increases. Conversely, when the soil is rewetted, the resistance lowers. The relationship of ohms of resistance to centibars (cb) or kilopascals (kPa) of soil water tension is constant.

The Watermark is calibrated to report soil water tension or matric potential, which is the best reference of how readily available soil water is to a plant. The raw data reported by the sensor for the watermarks is a frequency that increases as the watermark gets more saturated. Please refer to the [TRM](#) for information on how to convert the frequency to Soil Water Tension.

**NOTE:** The Watermark sensors need to be installed **wet** for best performance:

- immerse sensors halfway in water for 30 minutes in the morning, let dry until evening
- repeat the process in the evening: wet for 30 minutes, dry overnight
- wet again for 30 minutes the next morning, and let it dry until evening
- soak through the night and install **wet**

There are several things to note regarding installation depending on the use case for the Watermark sensor. Please review the installation and operations instructions the [CLOVER / KIWI - Application Notes](#).

- **CLOVER Probe – CLOVER only:** Option to measure soil moisture content and temperature. The probes work in a similar manner to the Watermark Sensor described above. There is no exchange of water with the surrounding soil. However, the probes simply measure how saturated and warm or cold the soil is and provides a frequency reading. Please refer to the TRM for information on how to convert the frequency to Gravimetric Water Content.
- **MCU Temperature:** Reports temperature of the MCU.

## 1.2 Specifications

The Agriculture Sensor specifications are listed in Table below.

**Table 2: Agriculture Sensor Specifications**

Attribute	Specification
Use Environment	Indoor, Outdoor
Environmental Rating	IP67
Operating Temperature	-20°C to 60°C
Storage Temperature for Optimal Battery Life	-40°C to 75°C
Operating Relative Humidity	0%–100%, condensing
Storage Relative Humidity	0%–100%, condensing
Size	CLOVER Sensor: 120 mm x 90 mm x 58 mm (H=161mm with probes) KIWI Sensor: 120 mm x 90 mm x 47 mm
Weight	Soil CLOVER Sensor: 224g KIWI Sensor: 220g (233g with mounting plate)
Power Source	Battery powered: 1x C-cell Lithium Thionyl Chloride (LTC) 3.6V  <b>NOTE:</b> If replacing the battery, please ensure it is inserted with the correct polarity.
Network technology/Frequency band	LoRaWAN in multiple variants (see Table 1): US 902-928 MHz, EU 863-870 MHz
Air Interface	LoRa
Battery Lifetime	At least 10 years with a baseline use case: transmission at maximum power every 15 minutes at room temperature
Maximum Tx Power	Up to 23 dBm
LED	Green: Joining the network activity Red: LoRa TX or RX activity
Sensing Functions	ambient temperature, ambient humidity, ambient light, accelerometer, battery level, water tension, soil moisture, soil temperature, MCU temperature
Ambient Temperature	$\pm 0.2^{\circ}\text{C}$ within temperature measurement range of -40°C to 125°C* Resolution: 0.1°C
Relative Humidity	$\pm 2\%$ RH within temperature measurement range of -0%–100%, condensing* Resolution: 0.1%

<b>Ambient Light Intensity</b>	0 to 65,535 lux Resolution: 1 lux
<b>MCU Temperature</b>	$\pm 5^{\circ}\text{C}$ within temperature measurement range of -40°C to 85°C* Resolution: 1°C
<b>Soil Moisture, Input 1<sup>1</sup></b>	$\pm 1$ kHz between 1322 kHz – 1402 kHz (120% GWC – 0% GWC) Resolution: 1 kHz, 10% GWC
<b>Soil Temperature, Input 2<sup>1</sup></b>	$\pm 2^{\circ}\text{C}$ within -15°C to +60°C Resolution: 0.1°C
<b>Input 3 &amp; 4 as thermistor<sup>2</sup></b>	$\pm 2^{\circ}\text{C}$ within -15°C to +60°C Resolution: 0.1°C
<b>Input 3 &amp; 4 as onewire<sup>2*</sup></b>	$\pm 0.5^{\circ}\text{C}$ within -10°C to +85°C Resolution: 0.1°C
<b>Watermark (Input 5 &amp; 6)<sup>2*</sup></b>	$\pm 1$ kPa within 0 to 239 kPa Resolution: 1 kPa

---

<sup>1</sup> Applicable to CLOVER only

<sup>2</sup> Applicable to KIWI only

\*From the manufacturer datasheet.

## 2 Installation

### 2.1 Included Product and Installation Material

The following items are shipped with each sensor:

- LoRa IoT Agriculture Sensor
- LTC C-cell battery installed in the sensor

**NOTE:** A magnet is required to wake up the sensor from state of DEEP SLEEP the sensor is shipped in. TEKTELIC does NOT provide this magnet in the sensor packaging.

Suggested magnet:

- Type: Sintered Ferrite Magnet
- Specification:
  - Residual Magnetic Flux Density = 3800-3900 Gauss
  - Grade:
    - Grade 5 (Grade Y30) or
    - Grade 8 (Grade Y30H-1)

### 2.2 Safety Precautions

The following safety precautions should be observed:

- The Agriculture Sensor is not a toy, PLEASE KEEP AWAY FROM CHILDREN.
- Use only the specified Lithium Thionyl Chloride (LTC) C-cell batteries.
- Do not exceed the maximum specified terminal voltages.
- All installation practices must be in accordance with the local and national electrical codes.
- Sensor inputs do not provide electrical isolation between each other.

### 2.3 Unpacking and Inspection

The following should be considered during the unpacking of a new Agriculture Sensor:

- Inspect the shipping carton and report any significant damage to TEKTELIC.
- Unpacking should be conducted in a clean and dry location.



- Do not discard the shipping box or inserts as they will be required if a unit is returned for repair or re-configuration.

## 2.4 Equipment Required for Installation

The following tools are required to install the Agriculture Sensor:

- Torx T10 screwdriver (8 x enclosure screws)
- Slotted screwdriver (internal terminal block connections)
- Wire Stripper
- Wire Cutter

## 2.5 Commissioning

Each sensor has a set of commissioning information that must be entered into the network server

for the sensor to be able to join the network and begin normal operation once activated. For instructions on how to do this please refer to the Network Server Quick Start Guide you get in the box with the device (also available online in the [Knowledge Base](#)).

You can find the commissioning keys inside the box. If you don't have the box, please raise a ticket in our support portal and provide the Tcode and serial number on the tag placed on the device.



Figure 1 Kiwi / Clover Commissioning Keys

NOTE: to ensure devices safe installation and maintenance please read Safety Precautions.

## 2.6 Reed Switch Awakening Procedure

**NOTE:** Early versions of the Agriculture Sensor were shipped with tape over the positive terminal of the battery. Therefore, if the wakeup pattern described below doesn't work, the battery should be checked, and tape removed if necessary.

The Agriculture Sensor is equipped with a magnetic reed switch. The reed switch can be operated by a magnet, and is used for the following purposes:

- 1) MCU reset upon observing a specified magnetic pattern:

**To activate/reset the device:**

- i. Place magnet for **3 to 10 seconds** against the enclosure at the magnetic activation site as shown in Figure 2 below.
- ii. Sensor activation will be displayed by **GREEN** and **RED** LEDs turning on.
- iii. Once activated, the sensor will automatically begin the join process.

**NOTE:** The sensor may take a few minutes to join the network for the first time due to the new battery firing up for the first time. This delay should not exceed 10 minutes.

The magnet sign is illustrated in 2 below:

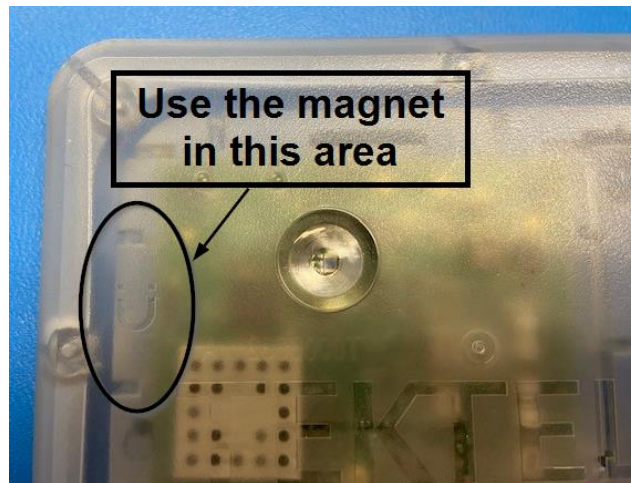

**Figure 2: Reed switch location**

- 2) Triggering the Agriculture Sensor to uplink by briefly applying a magnet to a magnet sign for up to 2 seconds.

This is used to get the LoRaWAN Class-A Agriculture Sensor to open a receive window so it can receive DL commands from the NS, or simply to trigger the Agriculture Sensor to uplink some desired transducer data.

**NOTE:** Replacing the batteries does not cause the Agriculture Sensor to go to DEEP SLEEP. Once new battery is inserted, Sensor boots up and tries to join a LoRaWAN network.

## 2.7 KIWI Sensor Mounting

On the KIWI model of the Agriculture Sensor, there is a mounting bracket on the bottom of the unit as seen in Figure 3. These mounting holes can be used to screw the enclosure to a solid surface. The recommended mounting screw size is M3 or #6. Mounting screws are not provided with the sensor.

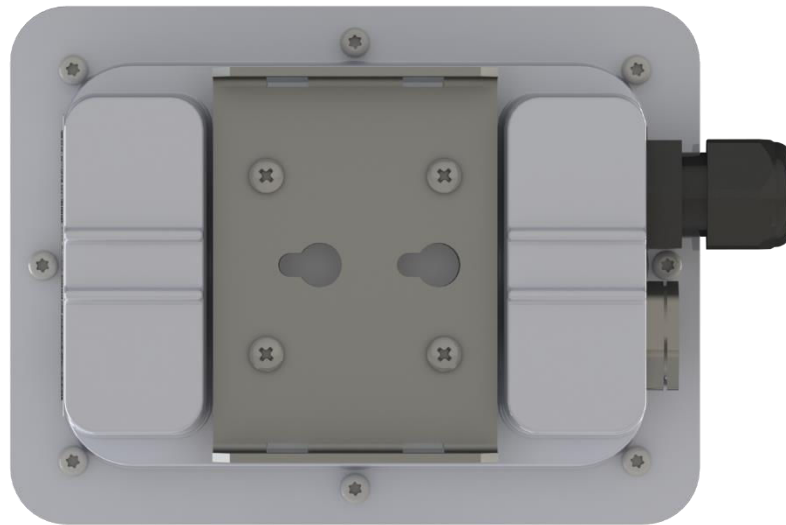

Figure 3: KIWI model showing the mounting holes.

The mounting surface must be capable of holding > 2 kg [4.5 lbs]. Clearance must be provided for the modules cable gland and input cable.

## 2.8 Cable Installation

The KIWI Sensor enclosure is provided with a waterproof cable gland through which all connections must be routed. The supplied cable gland size is PG-9. This gland supports cables with a jacket outside diameter of 2.67 mm to 8 mm (0.105" to 0.315").

The I/O terminal blocks accept 30-16 AWG wire. Select a cable that meets the application requirements and local and national electrical codes.

To install the cable:

- make the appropriate connections between the input cable and the terminal block.
- dress the internal wires so that the cable gland seals against the outer cable jacket. Finally, tighten the cable gland. **Error! Reference source not found.** below illustrates the customer accessible interfaces for the KIWI Sensor.

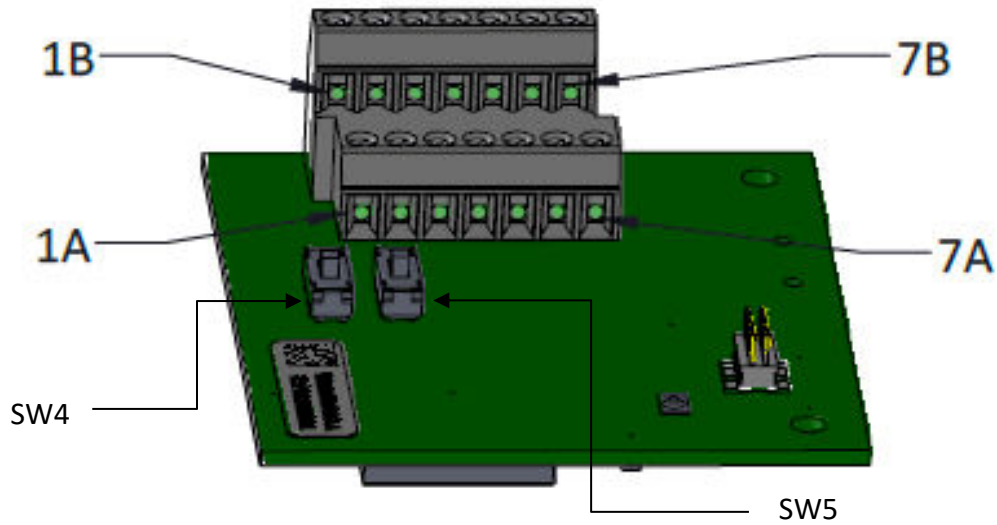

Figure 4: KIWI connector block for connecting external probes.

Legend:

1A = Input 2+ (RES)

1B = Input 1+ (RES)

2A = Input 2-

2B = Input 1-

7A = GND

7B = Power (RES)

SW4 = Switch for Input 3

SW5 = Switch for Input 4<sup>3</sup>

**RES = Reserved pins for CLOVER Module Only**

See **Error! Reference source not found.** and **Error! Reference source not found.** for input connections.

Signal connections should be connected to the positive terminal (labeled '+'). Similarly, the return path should be connected to the negative terminal (labeled '-') of the matching I/O channel.

**NOTE:** KIWI Sensor I/O are referenced to the sensor ground and are not isolated.

Table 2: Wiring and Switching Information for Thermistor Connection

Input	Interface Wiring			Required Switches Position <sup>4</sup>	
	Wire Color	Polarity	Terminal Block Pin	SW4	SW5
3 only	White	POSITIVE	3A	"THERM" position	"THERM" position
	Black	NEGATIVE	4A		
4 only	White	POSITIVE	5A		

<sup>3</sup> SW4 and SW5 are not supported in HW revision lower than F0

<sup>4</sup> The switches are in the "Therm" position by default

	Black	NEGATIVE	6A	“THERM” position	“THERM” position
3 and 4	White	POSITIVE	3A, 5A	“THERM” position	“THERM” position
	Black	NEGATIVE	4A, 6A		

**Table 4: Wiring and Switching Information for One wire Connection**

Input	Interface Wiring			Required Switches Positions	
	Wire Color	Polarity	Terminal Block Pin	SW5	SW6
3 only	Yellow	DATA	3A	“1-WIRE” position	“THERM” position
	Red	POWER	7B		
	Black/Blue	GROUND	7A		
4 only	Yellow	DATA	5A	“THERM” position	“1-WIRE” position
	Red	POWER	7B		
	Black/Blue	GROUND	7A		
3 and 4	Yellow	DATA	3A, 5A	“1-WIRE” position	“1-WIRE” position
	Red	POWER	7B		
	Black/Blue	GROUND	7A		

## 2.9 Default Configuration

### 2.9.1 Default Configuration for CLOVER

The default configuration of the **CLOVER** Sensor for reporting transducer readings includes the following:

**Table 5: Default Configuration - CLOVER**

Parameter	Value
Seconds per Core Tick	900 (15 min)
Ticks per battery voltage measurement	96 (24-hours)
Ticks per Ambient Temperature	1 (15 min)
Ticks per Ambient Relative Humidity	1 (15 min)
Ticks per Soil Moisture	1 (15 min)
Ticks per Soil Temperature	1 (15 min)
Ticks per Ambient Light	1 (15 min)

### 2.9.2 Default Configuration for KIWI

The default configuration of the **KIWI** Sensor for reporting transducer readings includes the following:

**Table 6: Default Configuration - KIWI**

Parameter	Value
Seconds per Core Tick	900 (15 min)
Ticks per battery voltage measurement	96 (24-hours)

Ticks per Watermark 1	1 (15 min)
Ticks per Watermark 2	1 (15 min)
Ticks per Ambient Light	1 (15 min)

## 2.10 Reconfiguration

The Agriculture Sensor supports a full range of Over-the-Air (OTA) configuration options. Specific technical details are available in the [Agriculture Sensor Technical Reference Manual](#). All configuration commands need to be sent OTA during a sensor's downlink windows.

## 2.11 LED Behaviour

The LEDs are located on the top of the Agricultural Sensor. See **Error! Reference source not found.** below for a photo of LED location.

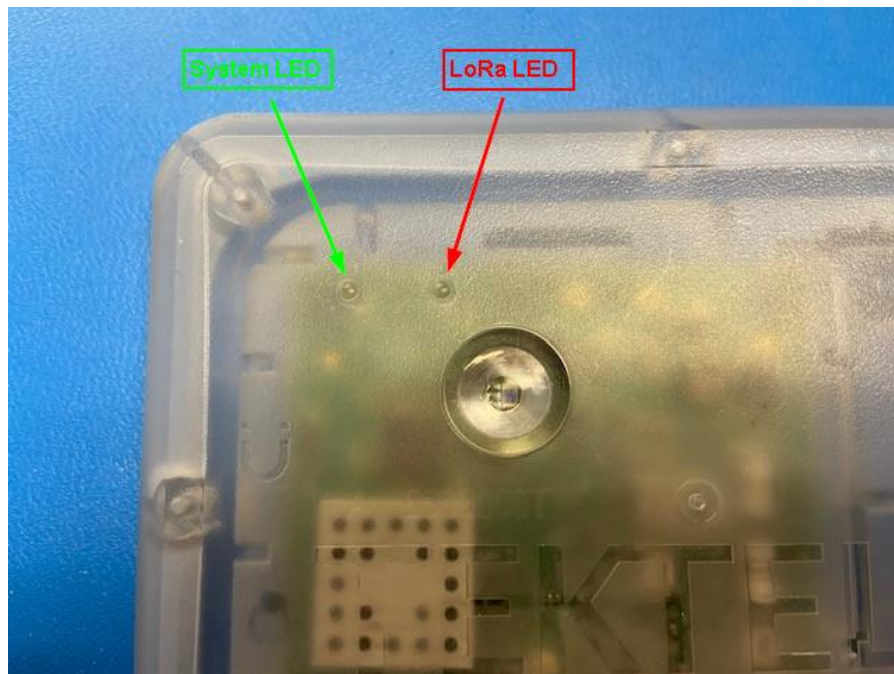

Figure 5: LED Location

Table 7: LED Behaviour

Situation	LED Status	Description
During boot and join	Both LEDs briefly on	Both LEDs come on briefly when power is first applied.
	LEDs turn off, one blinks briefly	After a small delay (< 1 second), the LEDs will turn off, and one of them will blink briefly.
	System (green) LED blinks	If the System (green) LED blinks, then all health checks on the board have passed.

	LoRa LED (red) blinks	If the LoRa LED (red) blinks, then one of the health checks has failed. Consider replacing the battery, or moving the sensor to an environment within the temperature range.
	System LED blinks continuously	Immediately after the delay, the join procedure will begin. During this time, the System LED will blink continuously until the sensor joins a network. Note that the device may take longer to join for the first wake-up from deep sleep.
	LoRa LED blinks for LoRa activity	The LoRa LED will now blink whenever LoRa activity occurs on the sensor (transmitting or receiving packets).
During normal operation	LoRa LED blinks for LoRa activity	The LoRa LED will blink whenever LoRa activity occurs on the sensor (transmitting or receiving packets).
	System LED activity	The System LED can be controlled via the downlink command interface.

### 2.12 Battery Replacement

Open up the Agriculture Sensor using a #10 Torx screwdriver. The Agriculture Sensor has 8x enclosure Torx screws at the bottom. Be careful not to misplace the silicone cover gasket from the top lid.

Replace the battery. The Agriculture Sensor accepts C-size, 3.6 V, LTC batteries. The allowed replacement batteries are as follows:

- Xeno Energy, part number: XL-145F
- Tadiran Battery, part number TL-4920/S
- Tadiran Battery, part number TL-5920/S

Once the Agriculture Sensor is powered and tries to join (see Table 7 in previous section for LED behavior), replace the cover and gasket. Make sure that the gasket is properly seated in the cover before placing on the Agriculture Sensor housing. Tighten the 8 cover screws to 2.5 lbf-in (30 N-cm).

### 3 Agriculture Sensors Types Functions

#### 3.1 CLOWER Enclosure

An illustration of the CLOWER Sensor in the enclosure can be seen in **Error! Reference source not found.** and **Error! Reference source not found.** below. The CLOWER Sensor houses two PCBA's which provide all the functionality required by the product.

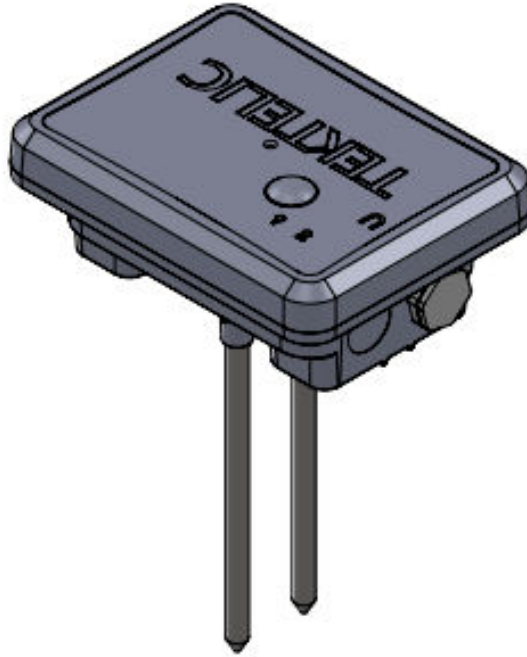

Figure 6: CLOWER Module - Exterior view

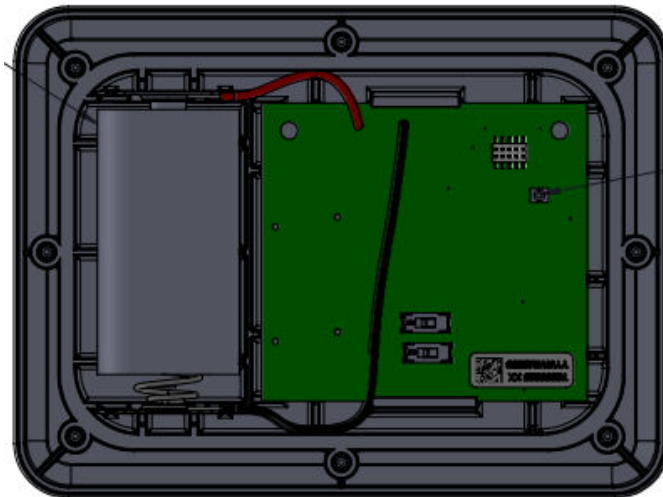

Figure 7: CLOWER Module – interior view



## 3.2 KIWI Enclosure

An illustration of the KIWI Sensor in the enclosure can be seen in **Error! Reference source not found.** and **Error! Reference source not found.** below. The KIWI Sensor houses one PCBA which provides all the functionality required by the product.

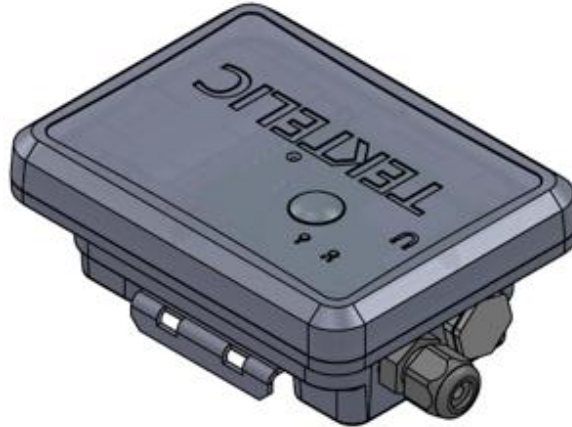

Figure 8: The Agricultural Sensor KIWI model - External view

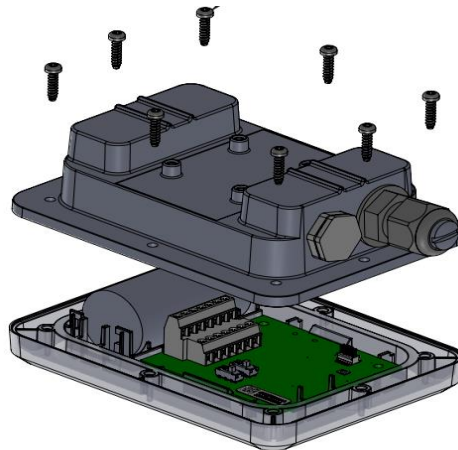

Figure 9: The Agricultural Sensor KIWI model - Internal View

The enclosure, measured at 120 mm x 90 mm x 58 mm (H=161mm with probes) for the CLOVER model and 120 mm x 90 mm x 47 mm for the KIWI model, is a custom design by Tektelic. It is a water-tight enclosure that is modified to add a humidity vent, as well as a water-tight cable gland for connection to external transducers.

The case is opened by removing the eight Phillips screws in the bottom of the enclosure and opening the lid allowing access to the power and input terminals.

The battery holder is adhered to the inside of the case lid and is a standard C-cell holder for an LTC battery. Replacement of the battery is accomplished by opening the lid as described above, replacing the cell in the holder, and securing the lid to the enclosure again.

### 3.2.1 Physical Interfaces – KIWI Only

**Error! Reference source not found.** below illustrates the customer accessible interfaces for the KIWI Sensor.

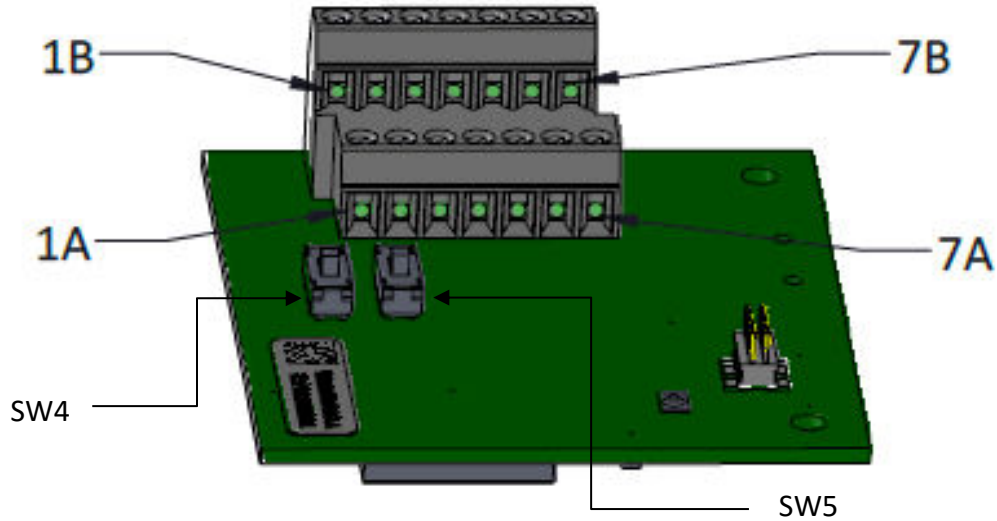

**Figure 10: KIWI connector block for connecting external probes.**

Legend:

1A = Input 2+ (**RES**)

2A = Input 2-

3A = Input 3 (Thermistor 1) \*

4A = Input 3 (Thermistor 1) \*

5A = Input 4 (Thermistor 2) \*

6A = Input 4 (Thermistor 2) \*

7A = GND

SW4 = Switch for Input 3 **Error! Bookmark not defined.**

**RES = Reserved pins for CLOVER Module Only**

1B = Input 1+ (**RES**)

2B = Input 1-

3B = Moisture 1 (Watermark 1) \*

4B = Moisture 1 (Watermark 1) \*

5B = Moisture 2 (Watermark 2) \*

6B = Moisture 2 (Watermark 2) \*

7B = Power (**RES**)

SW5 = Switch for Input 4<sup>5</sup>

<sup>5</sup> SW4 and SW5 are not supported in HW revision lower than F0



Figure 11: Input 3 and 4 Switches showing “SW4” and “SW5” default positions

### 3.2.2 Analog Thermistors – Inputs 3 and 4

The KIWI sensor supports the connection of up to two analog thermistor probes at the same time. **Error! Reference source not found.** below shows the only type of analog thermistor supported by the KIWI variant.

Table 8: Analog thermistor supported by KIWI variant.

Probe type	Part Number	Product T-code
Analog thermistor	TT02-10KC8-T105-1500	T0006993

Analog thermistor probes can be used for temperature measurement by connecting the thermistor’s connectors to input 3 and input 4. **Error! Reference source not found.** below provide the interface wiring and switch positions for all possible thermistor connections to the KIWI.

Table 9: Wiring and Switching Information for Thermistor Connection

Input	Interface Wiring			Required Switches Position <sup>6</sup>	
	Wire Color	Polarity	Terminal Block Pin	SW4	SW5
3 only	White	POSITIVE	3A	“THERM” position	“THERM” position
	Black	NEGATIVE	4A		
4 only	White	POSITIVE	5A	“THERM” position	“THERM” position
	Black	NEGATIVE	6A		
3 and 4	White	POSITIVE	3A, 5A	“THERM” position	“THERM” position
	Black	NEGATIVE	4A, 6A		

<sup>6</sup> The switches are in the “Therm” position by default

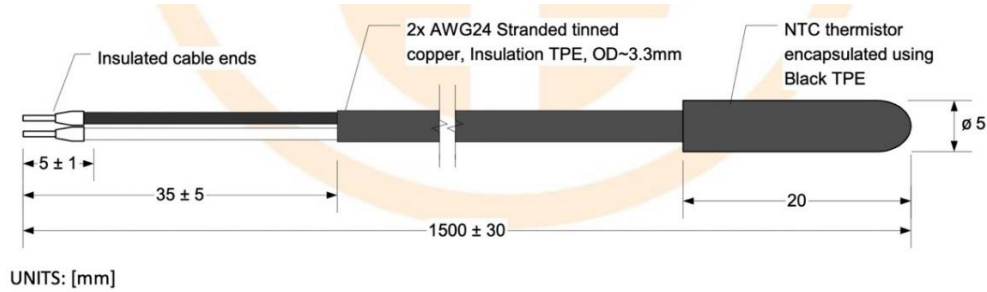

Figure 12: Structural diagram of TT02-10KC8-T105-1500 (TEWA Temperature Sensors, 2015)

### 3.2.3 One wire Probes - Inputs 3 and 4<sup>7</sup>

The KIWI sensor supports the connection of up to two digital One wire probes at the same time. below shows the supported digital one wire probe. **Error! Reference source not found.** below shows the one wire probe supported by the KIWI variant.

Table 10: Digital one wire temperature probe supported by KIWI variant.

Probe type	Part Number	Product T-code
Digital One wire	DFR0198	T0008632

By connecting these probes to input 3 or input 4 and switching the corresponding switches to the required position as shown in **Error! Reference source not found.** below, the KIWI sensor can measure and report temperature values.

Table 11: Wiring and Switching Information for One wire Connection

Input	Interface Wiring			Required Switches Positions	
	Wire Color	Polarity	Terminal Block Pin	SW5	SW6
3 only	Yellow	DATA	3A	"1-WIRE" position	"THERM" position
	Red	POWER	7B		
	Black/Blue	GROUND	7A		
4 only	Yellow	DATA	5A	"THERM" position	"1-WIRE" position
	Red	POWER	7B		
	Black/Blue	GROUND	7A		
3 and 4	Yellow	DATA	3A, 5A	"1-WIRE" position	"1-WIRE" position
	Red	POWER	7B		
	Black/Blue	GROUND	7A		

<sup>7</sup> Only supported on SW version 1.0.0 and above and HW revision F0 and above

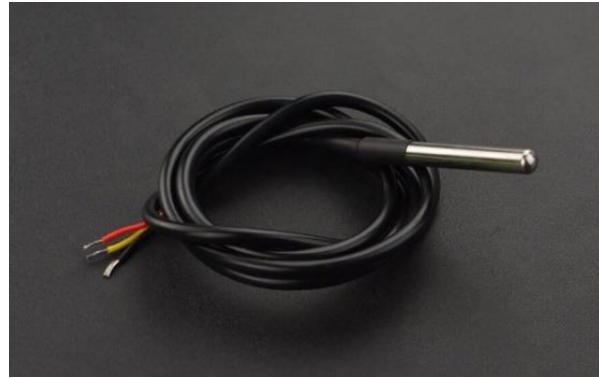

Figure 13: One-wire Temperature Probe (DFRobot, n.d.)

### 3.2.4 Watermark Probes - Inputs 5 and 6

KIWI supports the connection of up to two watermark sensors for soil tension measurement.

Table 12: Supported Watermark Probes for KIWI variant

Probe type	Part Number	Product T-code
Watermark	200SS-5	T0005013

Wiring arrangement in **Error! Reference source not found.** should be followed when connecting the watermark probes.

Table 13: Wiring Information for Watermark Connection

Input	Interface Wiring		
	Wire Color	Polarity	Terminal Block Pin
5	GREEN	POSITIVE	3B
	GREEN/WHITE	NEGATIVE	4B
6	GREEN	POSITIVE	5B
	GREEN/WHITE	NEGATIVE	6B

**NOTE:** watermark sensors do not require any form of switching for operation because watermark probes don't share interfaces with any other probe types.

**NOTE:** A sensor restart is required after any probe installation.



Figure 14: Watermark Sensors (Irrrometer, n.d.)

## 4 Basic Downlinks

Agriculture Sensor uses a "tick" system for reporting data. Generally, the sensor will report most important data every tick. A tick can be measured in seconds.

There are two sets of settings that must be configured in conjunction - "Core reporting tick in seconds" and "Ticks per [data/report]".

"Core reporting tick in seconds" will determine the interval between ticks. For example, you may set it to 60 seconds or 180 seconds for each tick.

"Ticks per [data/report]" determines how many ticks it will take before the sensor reports any data. For example, if you set "Ticks per Battery report" to 2, it will take 2 ticks before the sensor reports battery data.

### To Change the Core Report To Every Minute

With LeapX application (you can get it on [Google Play](#) or [App Store](#)): write number 1 in the field minutes between reports, then click on save changes.

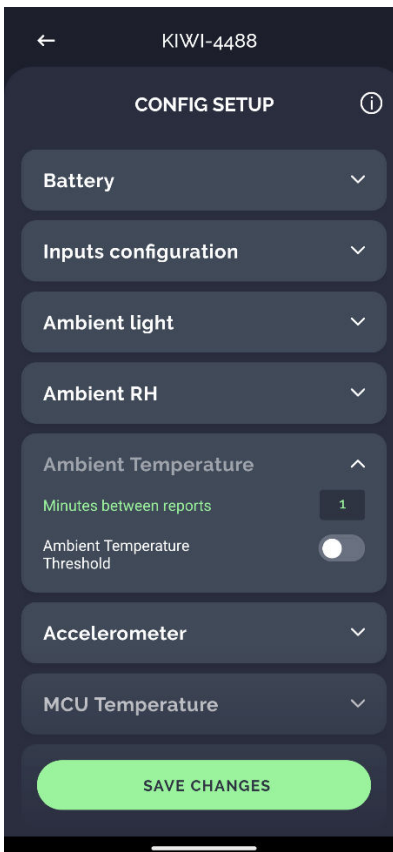

Figure 15: LeapX application

With ATLAS: check the box for Core report tick in seconds and ticks between ambient temperature reports. Write the values shown in the Figure 16 and click send.

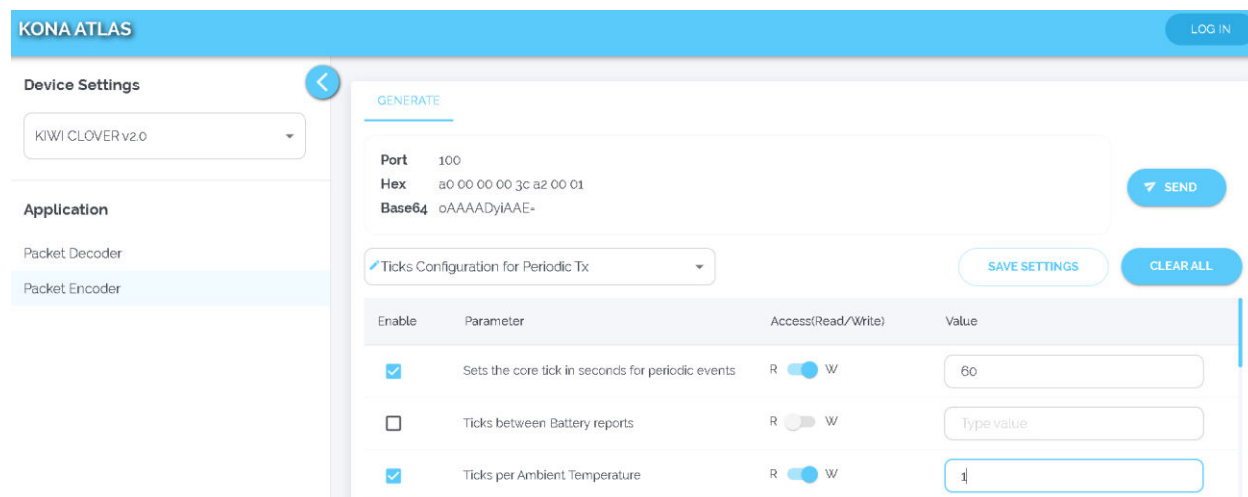

Figure 16: ATLAS

### Examples Of Uplinks

- 0x 00 D3 5A 00 BD 0A 0A

0x 00 D3 (Remaining Battery Capacity) = (0x 5A) = 90 x 1% = 90%

0x 00 BD (Remaining Battery Days) = (0x 0A 0A) = 2570 x 1day = 2570days

0x 01 04 05 79 02 02 02 D5

0x 01 04 (Soil Moisture) = 0x 05 79 = 1401 x 1kHz = 1401 kHz

0x 02 02 (Soil Temperature) = 0x 02 D5 = 725 x 0.001V = 0.725 V



## 5 Device Configuration with ATLAS

To perform more configuration or read the data of device you can use TEKTELIC's complementary service, [ATLAS](http://www.atlas.tektelic.com) at [www.atlas.tektelic.com](http://www.atlas.tektelic.com).

There are two ways to access ATLAS:

1) Using in Offline mode

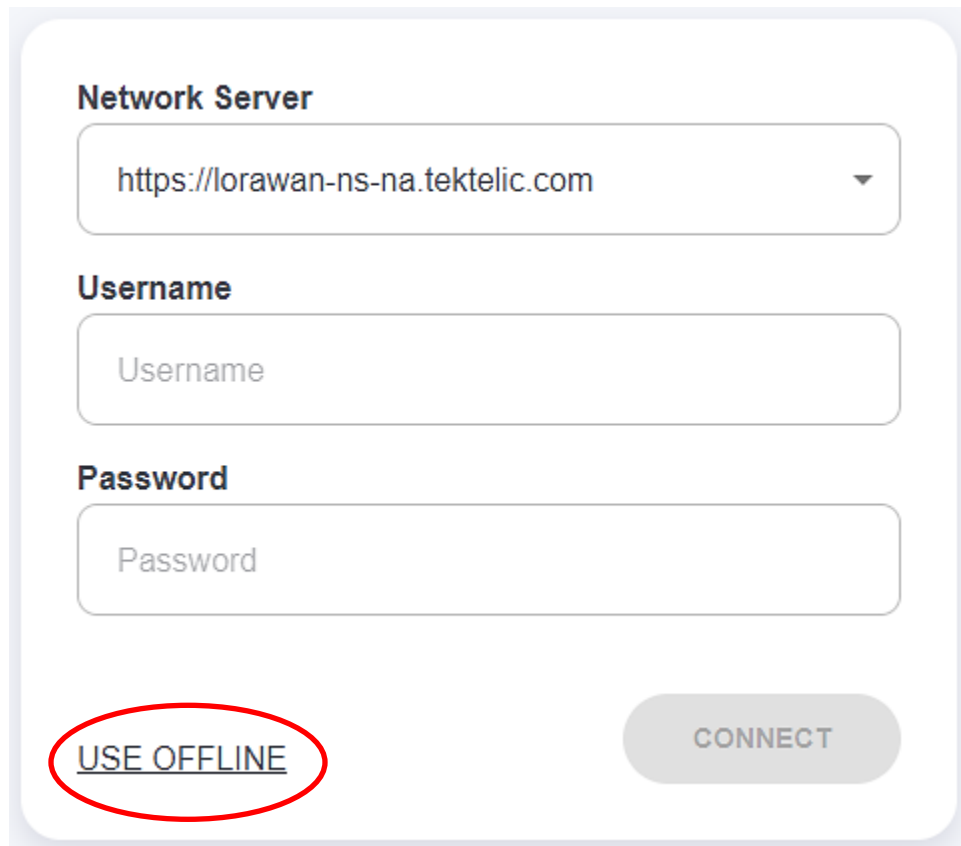

The screenshot shows a login form with the following elements:

- Network Server:** A dropdown menu containing the URL `https://lorawan-ns-na.tektelic.com`.
- Username:** A text input field with the placeholder text "Username".
- Password:** A text input field with the placeholder text "Password".
- Buttons:** A "CONNECT" button and a "USE OFFLINE" button. The "USE OFFLINE" button is circled in red.

Figure 17: Login as offline mode

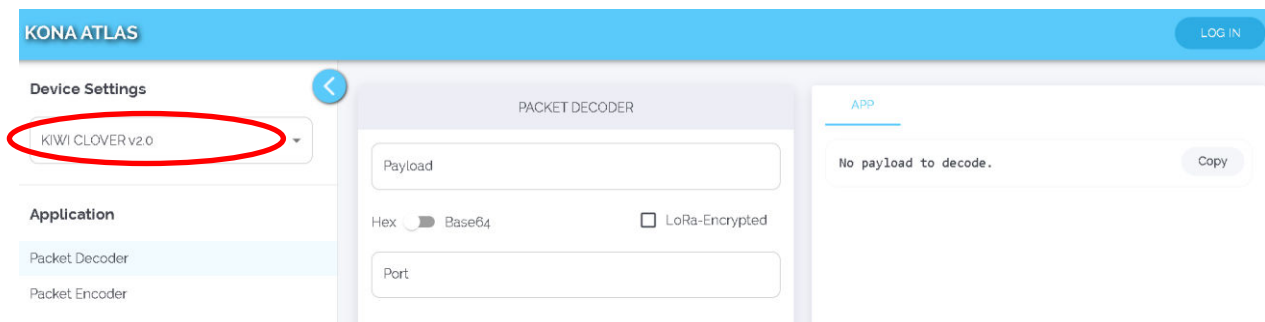

The screenshot shows the KONA ATLAS interface with the following elements:

- Header:** "KONA ATLAS" on the left and "LOG IN" on the right.
- Device Settings:** A dropdown menu with "KIWI CLOVER v2.0" selected, circled in red.
- Application:** A list of applications including "Packet Decoder" and "Packet Encoder".
- PACKET DECODER:** A section with a "Payload" input field, "Hex" and "Base64" radio buttons, a "LoRa-Encrypted" checkbox, and a "Port" input field.
- APP:** A section with a "No payload to decode." message and a "Copy" button.

Figure 18: Select KIWI/CLOVER decoder

2) with your TEKTELIC Network Server Credentials

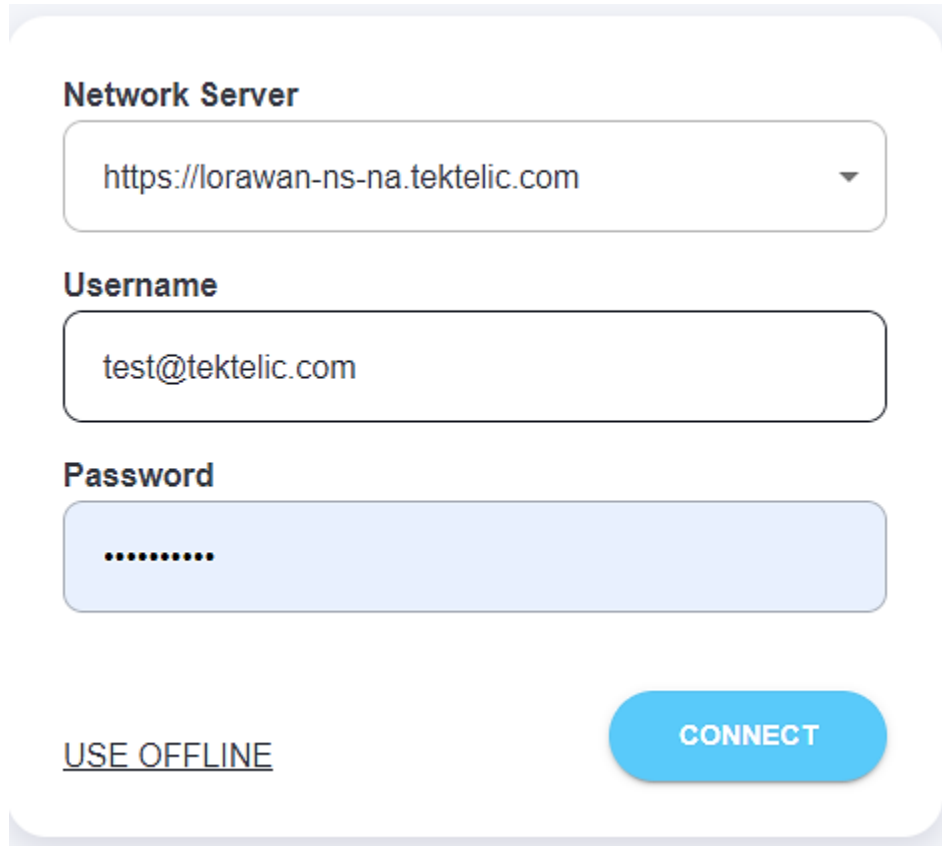

The image shows a login form with the following fields and buttons:

- Network Server:** A dropdown menu containing the URL `https://lorawan-ns-na.tektelic.com`.
- Username:** A text input field containing `test@tektelic.com`.
- Password:** A password input field with masked characters (dots).
- Buttons:** A blue rounded button labeled **CONNECT** and a text link labeled USE OFFLINE.

Figure 19: Login with Network server credentials

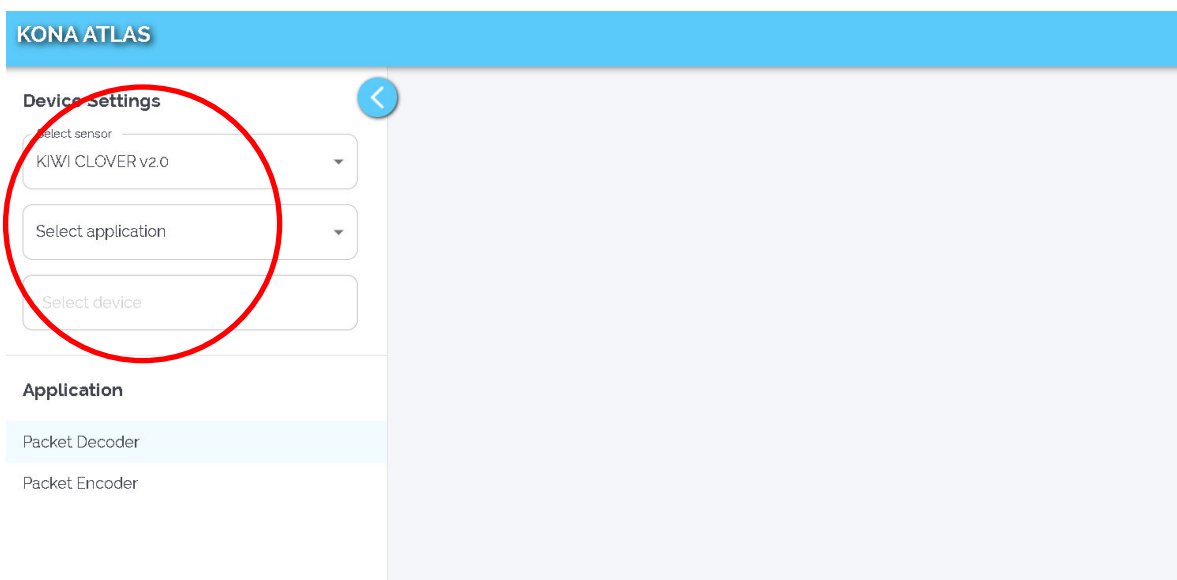

The image shows the KONA ATLAS interface with the following elements:

- Header:** KONA ATLAS
- Device Settings:** A sidebar menu with a back arrow. It contains three dropdown menus: "Select sensor" (set to KIWI CLOVER v2.0), "Select application", and "Select device". This entire section is circled in red.
- Application:** A list of application options: "Packet Decoder" (highlighted) and "Packet Encoder".

Figure 20: Select KIWI/CLOVER Decoder, application and the device

For more information follow this link <https://support.tektelic.com/portal/en/kb/articles/kona-atlas>

## 6 Data converters

Please follow this link: <https://github.com/TektelicCommunications/data-converters/tree/master> for the data converters that are to be used on TEKTELIC & other Network Server for TEKTELIC Sensors. These data converters can be used as a reference for other platforms.

TEKTELIC's data converters conform to the LoRa Alliance Payload Codec Specification and can be used with any 3<sup>rd</sup> party Network Server / Application Server that supports this specification.

<https://resources.lora-alliance.org/technical-specifications/ts013-1-0-0-payload-codec-api>

## 7 Troubleshooting

Question	Answer
<b>Why is the System LED rapidly blinking on my sensor?</b>	While a sensor is not joined to a network it will continuously blink the System LED to indicate its unconnected status to the user. Ensure your LoRaWAN gateway is connected to your Network Server and verify the DevEUI, AppEUI and AppKey for the device.
<b>Why does my LoRa LED blink periodically?</b>	The LoRa LED indicates LoRa traffic being sent or received by the device. A short blink indicates the sensor has just transmitted, while a longer blink indicates the sensor has received a message.
<b>How do I add my sensor to a Network Server?</b>	Provisioning a sensor on a Network Server will vary based on your Network Server provider. An example of how to perform this on the TEKTELIC Network Server is available in your sensor's user manual. Most network server providers will require you to enter the DevEUI, AppEUI and AppKey of your device on their service.
<b>What version of LoRaWAN do the sensors implement?</b>	All TEKTELIC Sensor products run LoRaWAN 1.0.2
<b>The serial numbers on my case are different from the serial numbers on the circuit board. Did my order get mixed up?</b>	All TEKTELIC products have multiple serial numbers so we can track the devices at each stage of production. It is normal that your sensor board and sensor assembly have different numbers.
<b>What can I find the commissioning values for my sensors? (DEVEUI, APPEUI and APPKEY)</b>	We keep the commissioning values for each sensor secure on our own server. We send the commissioning values for each sensor sent with a shipment but if this was misplaced, please send the serial number the revision and the Tcode of the sensor and we can get the information for you.
<b>Why is my sensor sending more packets than the Network Server receives?</b>	This occurs when the channel plan does not reflect the number of channels accepted by the gateway. By default, all sensors come up in 64 channel mode which results in lost packets if a gateway with less than 64 channels is used. If you have an 8-channel gateway for example, ensure this is configured in the device settings in the Network Server. In the TEKTELIC NS under the "advanced network settings" tab change the configuration of the "default channel mask" to reflect the number of channels used by the gateway used.

## 8 Compliance Statements

### Federal Communications Commission

This device complies with Part 15 of the FCC Rules. Operation is subject to the following two conditions:

1. This device may not cause harmful interference, and
2. This device must accept any interference received, including interference that may cause undesired operation.

To comply with FCC exposure limits for general population / uncontrolled exposure, this device should be installed at a distance of 20 cm from all persons and must not be co-located or operating in conjunction with any other transmitter.

Changes or modifications not expressly approved by the party responsible for compliance could void the user's authority to operate the equipment. This equipment has been tested and found to comply with the limits for a Class A digital device, pursuant to Part 15 of the FCC Rules. These limits are designed to provide reasonable protection against harmful interference in an industrial installation. This equipment generates uses and can radiate radio frequency energy and, if not installed and used in accordance with the instructions, may cause harmful interference to radio communications. However, there is no guarantee that interference will not occur in a particular installation. If this equipment does cause harmful interference to radio or television reception, which can be determined by turning the equipment off and on, the user is encouraged to try to correct the interference by one of the following measures:

- Reorient or relocate the receiving antenna.
- Increase the separation between the equipment and receiver.
- Connect the equipment into an outlet on a circuit different from that to which the receiver is connected.
- Consult the dealer or an experienced radio/TV technician for help.

### ***Innovation, Science and Economic Development Canada:***

This device contains license-exempt transmitter(s)/receiver(s) that comply with Innovation, Science and Economic Development Canada's license-exempt RSS(s). Operation is subject to the following two conditions:

- (1) This device may not cause interference.
- (2) This device must accept any interference, including interference that may cause undesired operation of the device.

This device should be installed and operated with minimum distance 0.2 m from human body.

L'émetteur/récepteur exempt de licence contenu dans le présent appareil est conforme aux CNR d'Innovation, Sciences et Développement économique Canada applicables aux appareils radio exempts de licence. L'exploitation est autorisée aux deux conditions suivantes :

- a. L'appareil ne doit pas produire de brouillage.
- b. L'appareil doit accepter tout brouillage radioélectrique subi, même si le brouillage est susceptible d'en compromettre le fonctionnement.

Cet appareil doit être installé et utilisé à une distance minimale de 0.2 m du corps humain.

### **Proposition 65**

 **WARNING:** This product can expose you to chemicals including lead, nickel & carbon black, which is known to the State of California to cause cancer, birth defects or other reproductive harm. For more information, go to [www.P65Warnings.ca.gov](http://www.P65Warnings.ca.gov).

## Document Revision

Revision	Issue Date	Status	Editor	Comments
0.1	June 4, 2019	Initial Draft	Emma Tholl	First draft.
0.2	January 28, 2020	Draft	Mark Oevering	Numerous updates Updated part numbers in Table 1.
0.3	April 6, 2020	Release candidate	Mark Oevering	Updated document to new template. Update to Compliance statement.
1.0	April 16, 2020	Release	Mark Oevering	Changes to naming convention for modules.
1.1	April 16, 2020	Release	Conor Karperien	Updated table for default configuration.
1.2	April 20, 2020	Release	Mark Oevering	Added note about using the sensor in direct sunlight. Changed default configuration in Tables 3 & 4 as a result. Added more detail about how soil moisture is measured between the two modules.
1.3	May 14, 2020	Release	Mark Oevering	Refined statement about direct sunlight in overview section. Change to magnetic wake-up pattern.
1.4	May 27, 2020	Release	Zenon Herasymiuk	Added battery polarity statement on Section 1.3
1.5	July 7, 2020	Release	Mark Oevering	Added Watermark information in Overview section
1.6	July 22, 2020	Release	Mark Oevering	Clarifications to table for Figure 3, Page 9
1.7	September 28, 2020	Release	Mark Oevering	Added note regarding tape over battery for early versions of the Agriculture Sensor
1.8	December 16, 2020	Release	Mark Oevering	Corrections to Table 2
1.9	April 5, 2021	Release	Mark Oevering	Added ALS range to Table 2
2.0	May 05, 2023	Release	Adedolapo Adegboye	Added Note on input 3 and 4 switches and possible delay after first wake up
2.1	16 November 2023	Release	Adedolapo Adegboye	Added disclaimer note in section 2.1 regarding activation magnet
2.2	28 June 2024	Release	Adedolapo Adegboye	Added a section detailing basic downlinks Added section for Kona Atlas Added section for converters