

# GEN2 BLE SENSOR FAMILY

## User Guide

**Document Type and #:** User Guide T0006940\_UG

**Document Issue:** 1.2

**Issue Date:** January 2, 2024

**Product Names  
and Codes  
(Module-Level):**

Contact Tracing Device (Indoor)	T0007126 – Belt-Mount T0007327 – Lanyard-Mount
SafeAlert (Indoor)	T0007127 – Belt-Mount T0007392 – Lanyard-Mount
Enterprise Asset Tracker (Indoor)	T0007379 – Base T0007128 – Wall-Mount
Contact Tracing Device (Outdoor)	T0007376 – Base T0007125 – Belt-Mount
Enterprise Asset Tracker (Outdoor)	T0007377 – Base T0006906 – Wall-Mount T0007378 – Probe T0006905 – Probe, Wall-Mount T0007381 – Lighthouse (Indoor) T0007296 – Lighthouse, Wall-Mount (Indoor)
Tundra Sensor (Outdoor)	T0006778 – Base T0007334 – Wall-Mount T0007380 – Probe T0006779 – Probe, Wall-Mount

**PROPRIETARY:**

The information contained in this document is the property of TEKTELIC Communications Inc. Except as specifically authorized in writing by TEKTELIC, the holder of this document shall keep all information contained herein confidential, and shall protect the same in whole or in part from disclosure to all third parties.

## Document Revision

Revision	Issue Date	Status	Editor	Comments
0.1	May 4, 2021	Obsolete	Carter Mudryk	Initial draft based on full BLE Gen2 UG (including ATEX) T0006940_UG_v0.1
0.2	June 1, 2021	Obsolete	Maheeka Wijesinghe	Updated Lighthouse variants T0007296 and T0007381 to be indoor use only (non-IP67) as per CSA results.
1.0	June 11, 2021	Obsolete	Carter Mudryk	Corrected the default battery UL interval for Tundra sensors to 1 hour.
1.1	Aug 10, 2022	Obsolete	S. Morrison	Corrected model t-code (T00006909 should be T00006906)
1.2	January 2, 2024	Released	SM	Clarified magnet is not included with product but provided on request

## Table of Contents

1	Product Description .....	8
1.1	Overview .....	8
1.2	Summary of Variant Groupings, Enclosures, and Features .....	9
1.3	External Appearance and Interfacing.....	13
1.4	Specifications and Sensing Functions .....	14
1.4.1	Bluetooth Low-Energy (BLE) Transceiver .....	15
1.4.2	Magnetic Reed Switch .....	16
1.4.3	Temperature and Relative Humidity Transducer.....	17
1.4.4	Accelerometer Transducer .....	17
2	Installation .....	18
2.1	Included Product and Installation Material .....	18
2.2	Safety Precautions .....	18
2.3	Unpacking and Inspection .....	18
2.4	Commissioning and Activation .....	19
2.5	Mounting .....	20
2.5.1	Mounting Procedure for AA-Cell Sensor Variants.....	20
2.5.2	Mounting Procedure for C-Cell Sensor Variants .....	20
2.6	Battery Replacement .....	22
2.6.1	Battery Replacement Procedure for AA-Cell Sensor Variants.....	22
2.6.2	Battery Replacement Procedure for C-Cell Sensor Variants .....	23
3	Operation, Alarms, and Management .....	27
3.1	Configuration.....	27
3.2	Default Configuration .....	27
3.3	RF LED Behaviour.....	27
3.4	Reset Function .....	28
3.5	Function Button.....	29
3.6	Buzzer and Vibration Feedback .....	29
4	Compliance Statements .....	30

References ..... 32

## List of Tables

Table 1-1: HW, Transducer, and Mechanical Capabilities of the Gen2 Sensor Family Variants...	11
Table 1-2: All Mechanical Enclosure / Mounting Combinations of the Gen2 Sensor Variants ....	12
Table 1-3: BLE Asset Tracker Specifications.....	14
Table 3-1: Default Reporting Periods of Functional Groupings .....	27

## List of Figures

Figure 1-1: Gen2 BLE Sensor Family Groupings and Hierarchy.....	9
Figure 1-2: AA-Cell Gen2 Sensor Variant Groupings by PCBA.....	10
Figure 1-3: C-Cell Gen2 Sensor Variant Groupings by PCBA .....	10
Figure 1-4: Gen2 Sensor Base Enclosures and External Interfacing (Front Views) .....	13
Figure 1-5: The BLE Scan Schematic Procedure.....	15
Figure 2-1: The C-Cell Sensor Variant Magnetic Activation Pattern .....	19
Figure 2-2: Securing the Mounting Bracket to a Surface.....	20
Figure 2-3: Attaching the Sensor to the Mounting Bracket.....	21
Figure 2-4: Securing the Sensor in the Mounting Bracket with a Fifth Screw.....	21
Figure 2-5: Using a Tool to Release the End-Cap.....	22
Figure 2-6: Battery Polarity Orientation .....	23
Figure 2-7: Replacing the PCBA and End-Cap .....	23
Figure 2-8: Removing the Battery Cover Screws .....	24
Figure 2-9: Battery Polarity Markers and Insertion .....	25
Figure 2-10: Proper Gasket Appearance .....	25
Figure 2-11: Proper Replacement Orientation of the Battery Cover .....	26

## List of Acronyms

<b>ATEX</b> .....	ATMospheres EXplosible
<b>BER</b> .....	Bit Error Rate
<b>BLE</b> .....	Bluetooth Low-Energy
<b>CNR</b> ....	Cahiers des charges sur les Normes Radioélectriques (RSS)
<b>DL</b> .....	DownLink
<b>EOS</b> .....	End Of Service
<b>EU</b> .....	European Union
<b>FCC</b> .....	Federal Communications Commission
<b>FW</b> .....	FirmWare
<b>HW</b> .....	HardWare
<b>IoT</b> .....	Internet of Things
<b>IP</b> .....	Ingress Protection
<b>ISM</b> .....	Industrial, Scientific, and Medical
<b>LED</b> .....	Light-Emitting Diode
<b>LoRa</b> ...	Long-Range
<b>LoRaWAN</b> .....	Long-Range Wide-Area Network
<b>LoS</b> .....	Line-of-Sight
<b>LTC</b> .....	Lithium-Thionyl Chloride
<b>MCU</b> ..	MicroController Unit
<b>NA</b> .....	North America
<b>NS</b> .....	Network Server
<b>OTA</b> ....	Over The Air
<b>PCB</b> .....	Printed Circuit Board
<b>PCBA</b> ..	Printed Circuit Board Assembly
<b>Rev</b> .....	Revision
<b>RF</b> .....	RadioFrequency
<b>RSS</b> .....	Radio Standards Specifications (CNR)
<b>RSSI</b> .....	Received Signal Strength Indicator
<b>Rx</b> .....	Receive, receiver, etc.
<b>SW</b> .....	SoftWare
<b>TRM</b> ...	Technical Reference Manual
<b>Tx</b> .....	Transmit, Transmitter, etc.
<b>UG</b> .....	User Guide
<b>UL</b> .....	UpLink
<b>US</b> .....	United States
<b>Ver</b> .....	Version

# 1 Product Description

## 1.1 Overview

This document provides a user manual for all of the device variants in the *BLE Sensor Family Gen2* developed by TEKTELIC Communications Inc (except the ATEX variants). This document includes descriptions of each variant and guides regarding the HW capabilities of each variant. For the functional operation and SW behaviour of each variant, please refer to the specific TRM document for that particular sensor.

All BLE Gen2 device variants are LoRaWAN-capable end-devices that are capable of supporting Tx/Rx in the following frequency bands as specified in the LoRaWAN Regional Parameters v1.0.2 [1]: AS923, AU915, EU868, IN865, KR920, RU864, US915. The variants that support BLE Tx/Rx operate in the 2.4 GHz band according to the BLE 5.0 specifications [2].

The Gen2 device family is the successor to the Gen1 device family. All sensors in the Gen2 family share a common internal printed circuit board (PCB), but have a variety of different transducers, functions, and use cases. There are four main functional categories of Gen2 devices (each of which is described in further detail in later sections):

- **Enterprise Asset Tracker:**
  - Available as Indoor (AA-cell battery) and Outdoor (C-cell battery) variants as well as the Lighthouse and Probe variants with different mounting options.
  - Main function: to utilize periodic BLE scanning to collect data from nearby BLE peripherals to determine device location.
- **SafeAlert:**
  - Only available as an Indoor (AA-cell) variant with different mounting options.
  - Main function: the same as the Enterprise Asset Tracker (utilizing BLE scans to track location) except the tracking function is activated through the use of a “panic” button. The button also triggers panic alerts.
- **Contact Tracing Device:**
  - Available as Indoor (AA-cell) and Outdoor (C-cell) variants with different mounting options.
  - Main function: to utilize periodic BLE scanning to detect other nearby contact tracing devices, alert when two or more devices are in close proximity, and save the data regarding contacted devices and contact durations. Contrary to the Enterprise Asset Trackers, the Contact Tracing devices do not track location.
- **Tundra Sensor:**



- Available as C-cell devices only, either with an external thermistor probe or without, and with different mounting options.
- Main function: to accurately measure temperature and humidity, specifically temperatures as low as -60°C for cold storage applications.

## 1.2 Summary of Variant Groupings, Enclosures, and Features

There are 19 total variants that belong to the BLE Gen2 Sensor Family (1 of which is the ATEX variant, which is not covered in this document). There are many commonalities between the variants; some share mechanical enclosures, others share function, etc. As such, there are three categories by which to group the variants:

1. By function (see Section 1.1).
2. By mechanical enclosure and mounting combination (See Table 1-2).
3. By PCBA (see Figure 1-2, Figure 1-3, and Table 1-1).

There are three “levels” of component from a production point of view, each of which has its own product code or “T-code.” All sensors share a single common PCB (one T-code). The PCBs are populated with different combinations of transducers/components to make seven different PCBAs (seven T-codes). The PCBAs are then combined with various mechanical enclosures, mounting options, and FW functionality to produce the 19 different variants at the module-level (19 T-codes). Figure 1-1 illustrates this hierarchy.

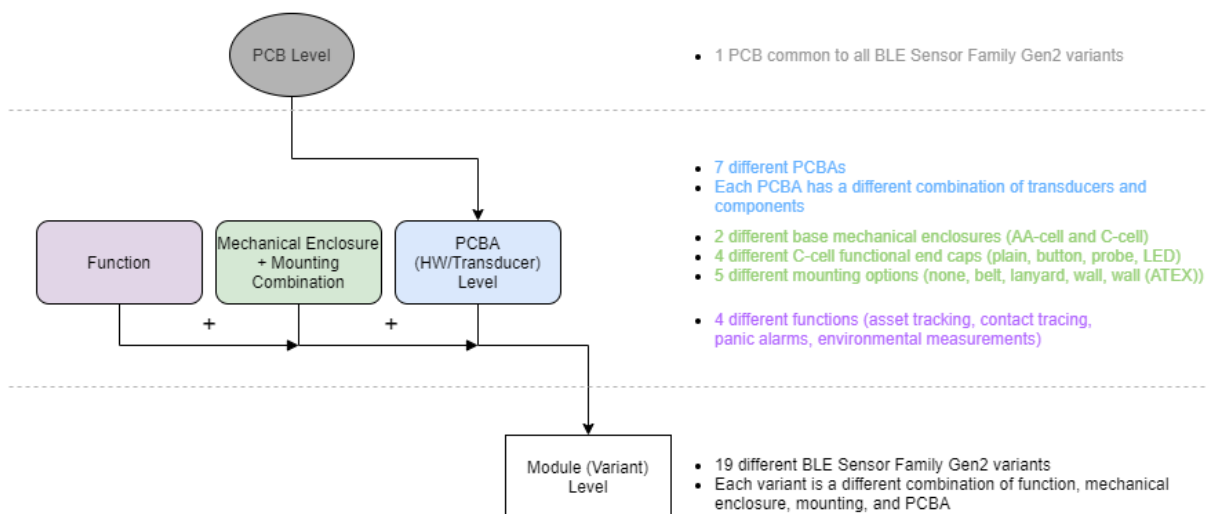

**Figure 1-1: Gen2 BLE Sensor Family Groupings and Hierarchy**

Figure 1-2 shows the HW/Mechanical groupings of the AA-cell variants and Figure 1-3 shows the groupings of the C-Cell Devices. In the figures, each grouping shares common PCBA HW (and

therefore PCBA-level T-code). The module-level T-code is what appears on the label on the exterior of the device. Each different combination of mechanical enclosure, mounting option, and function is assigned a different module-level product code, as shown in the figures.

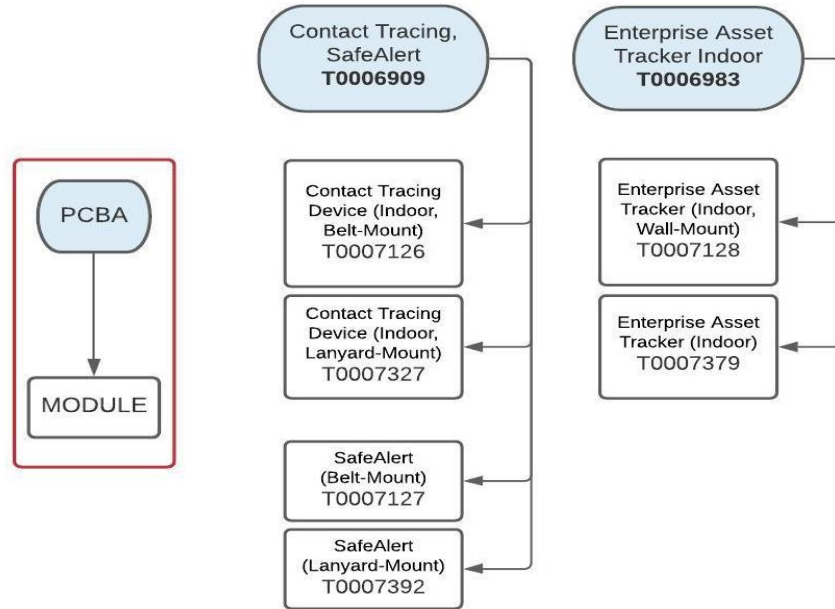

Figure 1-2: AA-Cell Gen2 Sensor Variant Groupings by PCBA

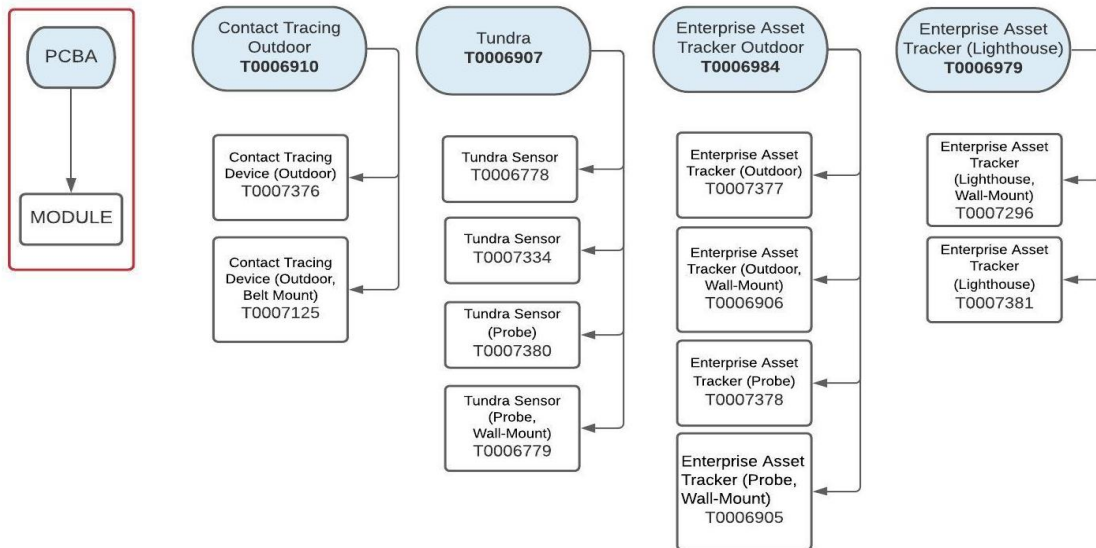

Figure 1-3: C-Cell Gen2 Sensor Variant Groupings by PCBA

Table 1-1 presents all 18 non-ATEX BLE Gen2 Sensor Family variants and which HW/Mechanical/Transducer functions are supported by each in matrix format.

**Table 1-1: HW, Transducer, and Mechanical Capabilities of the Gen2 Sensor Family Variants**

Feature / Transducer	Gen2 Sensor Family Variants																	
Grouping by PCBA T-Code (ref. Figure 1-2 and Figure 1-3)	Contact Tracing Device (Indoor) & SafeAlert T0006909				Enterprise Asset Tracker (Indoor) T0006983		Enterprise Asset Tracker (C-Cell) T0006984				Tundra Sensor T0006907				Contact Tracing Device (Outdoor) T0006910		Enterprise Asset Tracker (Lighthouse) T0006979	
Module Product Names	Contact Tracing Device (Indoor, Belt-Mount)	Contact Tracing Device (Indoor, Lanyard-Mount)	SafeAlert (Belt-Mount)	SafeAlert (Lanyard-Mount)	Enterprise Asset Tracker (Indoor)	Enterprise Asset Tracker (Indoor, Wall-Mount)	Enterprise Asset Tracker (Outdoor)	Enterprise Asset Tracker (Outdoor, Wall-Mount)	Enterprise Asset Tracker (Probe)	Enterprise Asset Tracker (Probe, Wall-Mount)	Tundra Sensor (Base)	Tundra Sensor (Wall-Mount)	Tundra Sensor (Probe)	Tundra Sensor (Probe, Wall-Mount)	Contact Tracing Device (Outdoor)	Contact Tracing Device (Outdoor, Belt-Mount)	Enterprise Asset Tracker (Lighthouse)	Enterprise Asset Tracker (Lighthouse, Wall-Mount)
Module Product Codes	T0007126	T0007327	T0007127	T0007392	T0007128	T0007379	T0007377	T0006906	T0007378	T0006905	T0006778	T0007334	T0007380	T0006779	T0007125	T0007376	T0007296	T0007381
Mounting	Belt	Lanyard	Belt	Lanyard		Wall		Wall		Wall		Wall		Wall		Belt		Wall
Supported Operating Environment	Indoor (IP30)				Indoor (IP30)		Outdoor (IP67)		Indoor (IP67)		Outdoor (IP67)		Indoor (IP67)		Outdoor (IP67)		Indoor (IP30)	
External Probe									✓				✓					
Battery Size	AA				AA		C				C				C		C	
Battery Gauge	✓				✓		✓		✓		✓		✓		✓		✓	
BLE Rx	✓				✓		✓		✓		✓		✓		✓		✓	
BLE Tx	✓														✓			
Reed Switch							✓				✓		✓		✓		✓	
Temperature + RH Transducer													✓					
Accelerometer	✓				✓		✓		✓		✓		✓		✓		✓	
Low-Intensity RF LEDs	✓				✓		✓		✓		✓		✓		✓		✓	
High-Intensity LED																	✓	
Reset Button	✓				✓													
Function Button	✓				Optional		Optional		Optional						✓		Optional	
Vibration	✓														✓			
Buzzer	✓														✓			

Table 1-2 shows all of the different mechanical enclosure and mounting options with the corresponding product codes.

**Table 1-2: All Mechanical Enclosure / Mounting Combinations of the Gen2 Sensor Variants**

Variant Name	Variant Product Code	Enclosure and Mounting
Contact Tracing Device (Indoor, Belt-Mount)	T0007126	
SafeAlert (Belt-Mount)	T0007127	
Enterprise Asset Tracker (Indoor, Wall-Mount)	T0007128	
Contact Tracing Device (Indoor, Lanyard-Mount)	T0007327	
SafeAlert (Lanyard-Mount)	T0007392	
Enterprise Asset Tracker (Indoor)	T0007379	
Contact Tracing Device (Outdoor)	T0007376	
Contact Tracing Device (Outdoor, Belt Mount)	T0007125	
Enterprise Asset Tracker (Outdoor)	T0007377	
Tundra Sensor	T0006778	
Enterprise Asset Tracker (Outdoor, Wall-Mount)	T0006906	
Tundra Sensor (Wall-Mount)	T0007334	
Enterprise Asset Tracker (Probe)	T0007378	
Tundra Sensor (Probe)	T0007380	
Enterprise Asset Tracker (Probe, Wall-Mount)	T0006905	
Tundra Sensor (Probe, Wall-Mount)	T0006779	
Enterprise Asset Tracker (Lighthouse)	T0007381	

Variant Name	Variant Product Code	Enclosure and Mounting
Enterprise Asset Tracker (Lighthouse, Wall-Mount)	T0007296	

### 1.3 External Appearance and Interfacing

Although the BLE Gen2 variants can be categorized into many different groups based on function, PCBA HW, or Mechanical enclosure/mounting combinations (as described in the previous sections), there are only two distinct groups with respect to the base enclosure and external interface layout. These groups are the AA-cell base enclosure variants and the C-cell base enclosure variants. The appearances and external interfacing layouts of both of these groups is shown in Figure 1-4.

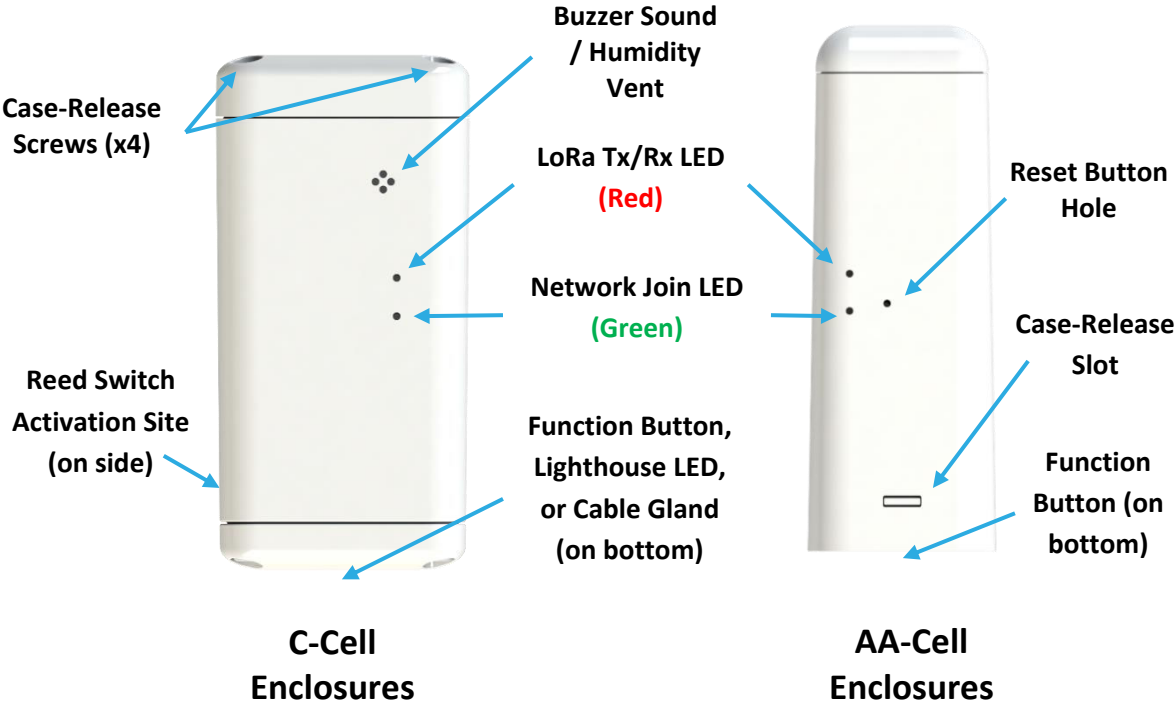

Figure 1-4: Gen2 Sensor Base Enclosures and External Interfacing (Front Views)

## 1.4 Specifications and Sensing Functions

The Gen2 BLE Sensor Family specifications are listed in Table 1-3. The main sensing functions are described in the following subsections.

**Table 1-3: BLE Asset Tracker Specifications.**

Parameter	Specification
Environmental Rating	IPX0 (AA-cell variants) IP67 (C-cell variants)
Enclosures and Mounting	Custom design by TEKTELIC
Operating Temperature	-20°C to 85°C (All variants except ATEX and Tundra Sensors) -60°C to 85°C (Tundra Sensors)
Storage Temperature for Optimal Battery Life	-40° to 50°C
Operating Relative Humidity	5% - 95% Non-condensing (AA-cell variants) 10% - 100% (C-cell variants)
Storage Relative Humidity	5% - 95% Non-condensing
Dimensions	72 mm x 28 mm x 32 mm (AA-cell variants) 66 mm x 32 mm x 44 mm (C-cell variants)
Weight	28.3 g enclosure + 17.5 g battery = 45.8 g total (AA-cell variants) 51.3 g enclosure + 56.5 g battery = 107.8 g total (C-cell variants)
Power Source	Battery-powered: 1x AA-cell LTC (3.6 V), or 1x C-cell LTC (3.6 V)
Network technology/Frequency band	LoRaWAN in the following Global ISM bands [1]: AS923, AU915, EU868, IN865, KR920, RU864, US915
Air Interface	LoRa, BLE
Maximum Tx Power	15 dBm (AS923, KR920, EU868) 22 dBm (AU915, IN865, US915)
Sensing Elements	BLE transceiver, accelerometer, thermometer, hygrometer, magnetic reed switch, battery gauge (not all sensing elements are available on all variants)
Bluetooth Compatibility	BLE based on Bluetooth 5
LoRa RF Sensitivity	Up to -137 dBm (SF12, 125 kHz BW)
BLE Sensitivity (0.1% BER)	125 kbps: -103 dBm 500 kbps: -98 dBm 2 Mbps: -91 dBm
Accelerometer Sensitivity	Sample rate: 1, 10, 25, 50, 100, 200, 400 Hz Measurement range: ±2, ±4, ±8, ±16 g Precision: 16, 32, 64, 192 mg
Function Button	Configurable function (Enterprise Asset Tracker variants) Panic alarm (SafeAlert variants) Forcing ULs and user feedback (Contact Tracing Device variants)
User Feedback	Buzzer and vibration motor (Contact Tracing Device and SafeAlert variants)

Parameter	Specification
LEDs	Green: Joining the network activity (all variants) Red: LoRa Tx or Rx activity (all variants) High-intensity white: controllable by user (Lighthouse variants only)
Battery Fuel Gauge Features	Measures battery voltage, current, and temperature EOS alert when the capacity is at 5%
Battery Lifetime	3 months (Contact Tracing Device, Indoor variants) 6 months (Contact Tracing Device, Outdoor variants) 1 year (Enterprise Asset Tracker, Indoor variants) 2 years (Enterprise Asset Tracker, C-cell variants) 5 years (SafeAlert variants) 9 years (Tundra Sensor variants)

### 1.4.1 Bluetooth Low-Energy (BLE) Transceiver

Some Gen2 variants are equipped with a BLE module that is embedded in the MCU. It serves as a BLE central device that periodically searches to discover nearby BLE peripherals, and in some cases, periodically broadcasts advertising packets to be visible to other devices. It can be used as a standalone proximity sensor that can also help at positioning.

The BLE scan can be disabled entirely or enabled at any time. Figure 1-5 shows the BLE scan scheme when the BLE scan is enabled. As shown in the figure, BLE scans are performed periodically. Each scan duration is divided into scan intervals. The BLE scan is performed only in the scan window portion of the scan interval. The ratio of the scan window to the scan interval is the scan duty cycle. In the case of the scan window equalling the scan interval, the scan duty cycle is 100%. This represents a continuous scan over each scan duration. A larger duty cycle will increase the likelihood of receiving more beacon packets at the expense of consuming more power. The scan period, duration, interval, and window are all configurable. For all user configurable device settings, refer to the specific TRM document for that sensor).

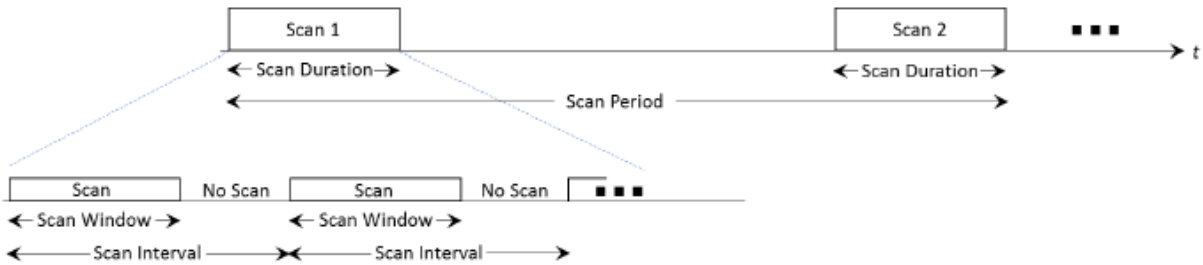

Figure 1-5: The BLE Scan Schematic Procedure.

In the case of the variants that fall into the Asset Tracking functional category, all BLE peripheral devices are discoverable during BLE scans. At the end of each scan duration, up to  $n$  discovered BLE devices with the strongest RSSIs are reported over LoRaWAN. The value  $n$  is user configurable. If no devices are found, an empty list is uplinked. Over each scan duration, a BLE device beacon may be observed (discovered) more than once. The Asset Trackers do not support BLE Tx advertising.

In the case of the variants that fall into the Contact Tracing functional category, only other Contact Tracing Devices are discoverable during the BLE scans. Signal strengths of discovered devices are analyzed over multiple scans to determine the proximity of these other devices. If a user-configurable threshold is breached, the Contact Tracing Device then begins recording the contact duration with that device, which is later sent over LoRaWAN once the contact has ended. Contact Devices are discoverable because they support BLE Tx advertising.

The Gen2 variants support BLE of Bluetooth 5.0. The BLE scan is performed in the passive mode only, meaning that the sensor listens to surrounding beacons, but does not transmit to them to request additional information.

**NOTE:** The BLE scan is exclusive to LoRa radio transmission; i.e. they do not overlap. If any reporting becomes due at the same time of a BLE scan, the reporting will be done after the BLE scan is complete.

## 1.4.2 Magnetic Reed Switch

The C-cell Gen2 sensor variants are equipped with an internal magnet actuated reed switch. Since the C-cell variants all have water-tight IP67 enclosures, there is no ability to have a battery pull-tab or reset button pinhole as in the AA-cell enclosures. The reed switch therefore address the following purposes:

1. To wake the device from sleep (the C-cell variants are shipped in a state of deep sleep).
2. To put the device to sleep.
3. To reset the device (since the C-cell variants do not have a reset button).
4. To force an UL.

A magnet for this purpose is available upon request. The position on the exterior of the enclosure on which the magnet must be placed to activate the reed switch is shown in Figure 1-4.

For more information on how to wake the device from sleep, refer to Section 2.4. For more information on how to use the reed switch for the other purposes, refer to the specific TRM document for the sensor.



### 1.4.3 Temperature and Relative Humidity Transducer

The Tundra Sensor variants contain a temperature and relative humidity (RH) transducer. Note that because the transducer element is located inside the sensor housing, sense response time will not be immediate. Two vents in the front and top cover of the enclosure are designed to allow ambient air to contact the transducer. Response time can be reduced by forcing air to move over the sensor in the region of the transducer opening.

All Gen2 sensor variants have the ability to measure and report the MCU temperature. This is a less accurate temperature measurement using a transducer located in the device microprocessor.

The sensors can be configured to report temperature and RH values or to report alarms based on a customer-configured normal operating window. High and low alarm points can be set individually for temperature, humidity and MCU temperature. The sample rate for checking the transducers is user configurable with different sample rates settable if the measured value is inside or outside the normal operating window.

### 1.4.4 Accelerometer Transducer

All Gen2 sensor variants support motion sensing through an integrated 3-axis accelerometer which can optionally be disabled. The main role of the accelerometer in the is to detect motion that can indicate a change of the sensor's status from stillness to mobility, or vice versa.

In the case of the variants that fall into the Contact Tracing functional grouping, the accelerometer is used to detect when the device has been immobile for a period of time and can therefore enter an inactivity state to conserve battery life.

In the case of all other variants, the accelerometer generates an acceleration alarm when a motion event is detected that may or may not be reported OTA (user-configurable). An acceleration event report is based on exceeding a defined acceleration alarm threshold count in a defined alarm threshold period. These thresholds can be customized such that there will not be multiple reports for a single event, depending on the definition of an event in a particular use case. An alarm event can only be registered after a configurable grace period elapses since the last registered alarm event. Carefully setting the grace period is important and prevents from repeatedly registering an accelerometer event.

The accelerometer can also be polled periodically for its output acceleration vector for applications in which the sensor's orientation is of interest.

## 2 Installation

### 2.1 Included Product and Installation Material

The following items are shipped with each sensor:

- 1x sensor inside an enclosure with 3.6 V AA-cell or C-cell LTC battery installed.
- 1x corresponding sensor Quick Start Guide.
- 1x mounting bracket (only for variants with mounting).

### 2.2 Safety Precautions

The following safety precautions should be observed for all Gen2 sensor variants:

- All installation practices must be in accordance with the local and national electrical codes.
- Replace only with approved batteries (see section 2.6).
- The following sensor variants are intended for indoor use only: T0006779, T0006905, T0007126, T0007127, T0007128, T0007126, T0007327, T0007378, T0007379, T0007380.
- The Tracker contains an LTC AA-cell or C-cell battery. When used correctly, lithium batteries provide a safe and dependable source of power. However, if they are misused or abused, leakage, venting, explosion, and/or fire can occur. The following are recommended safety precautions for battery usage [3].
  - **Keep batteries out of the reach of children.**
  - **Do not allow children to replace batteries without adult supervision.**
  - **Do not insert batteries in reverse.**
  - **Do not short-circuit batteries.**
  - **Do not charge batteries.**
  - **Do not force discharge batteries.**
  - **Do not mix batteries.**
  - **Do not leave discharged batteries in equipment.**
  - **Do not overheat batteries.**
  - **Do not weld or solder directly to batteries.**
  - **Do not open batteries.**
  - **Do not deform batteries.**
  - **Do not dispose of batteries in fire.**
  - **Do not expose contents to water.**
  - **Do not encapsulate and/or modify batteries.**
  - **Store unused batteries in their original packaging away from metal objects.**
  - **Do not mix or jumble batteries.**

### 2.3 Unpacking and Inspection

The following should be considered during the unpacking of a new sensor.

1. Inspect the shipping carton and report any significant damage to TEKTELIC.
2. Unpacking should be conducted in a clean and dry location.

3. Do not discard the shipping box or inserts as they will be required if a unit is returned for repair or re-configuration.

## 2.4 Commissioning and Activation

Each sensor has a set of commissioning information that must be entered into the network server in order for the sensor to be able to join the network and begin normal operation once activated. For instructions on how to do this please refer to the Network Server Quick Start Guide (available online in the *Knowledge Base*) [4].

The sensor is shipped in a secured enclosure with the battery preinstalled. In the case of AA-cell variants, the battery is disengaged by a pull tab. To activate an AA-cell variant, simply remove the battery pull-tab.

In the case of C-cell variants, the device is shipped in a state of deep sleep. A magnet can be used to wake the sensor from sleep by applying the magnetic activation pattern at the location specified on the device in Figure 1-4. The magnetic pattern is illustrated in Figure 2-1. A “magnet presence” is achieved by attaching the magnet to the enclosure at the magnet symbol. A “magnet absence” is achieved by taking the magnet away from the enclosure. Figure 2-1 shows that the pattern involves sustaining a “magnet presence” continuously for at least 3 s but less than 10 s.

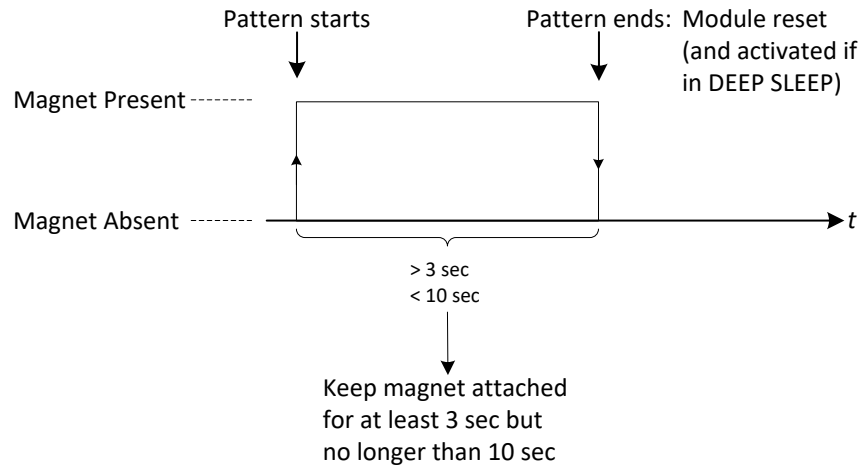

**Figure 2-1: The C-Cell Sensor Variant Magnetic Activation Pattern**

When any sensor variant is activated it will display an LED indication (described in Section 3.3) to show that it is beginning to join the network. It may take up to 10 seconds between the time of activation and the beginning of the LED join attempt pattern.

Once activated, the sensor will automatically begin the join process. To turn the sensor off, the battery must be removed. To reset the device, the external reset button can be pushed; see Section 3.4 for a description of the reset function.

Refer to Section 3.3 for the expected LED behaviour of the Tracker during the join process.

## 2.5 Mounting

### 2.5.1 Mounting Procedure for AA-Cell Sensor Variants

The only mounting options for the AA-cell sensor variants are the belt clip mount and the lanyard mount.

For the belt-clip variants, simply slide the clip over a belt or other surface to mount.

For the lanyard-mount variants, simply clip the fastener of a lanyard into the loop on the top piece of the enclosure.

### 2.5.2 Mounting Procedure for C-Cell Sensor Variants

1. The mounting bracket needs to be secured to a wall or another solid surface by using an adhesive, or four mounting screws (see Figure 2-2).



**Figure 2-2: Securing the Mounting Bracket to a Surface**

2. After the bracket has been secured, the sensor can be mounted to the bracket via the mounting feature on the main body of the sensor (see Figure 2-3). Slide the bottom hook of the mounting bracket into the mounting feature until it is fully inserted.



**Figure 2-3: Attaching the Sensor to the Mounting Bracket**

3. Using a fifth screw inserted through both holes on the top side of the bracket as shown in Figure 2-4, clamp the top flange of the bracket until it is flush with the top surface of the sensor.



**Figure 2-4: Securing the Sensor in the Mounting Bracket with a Fifth Screw**

## 2.6 Battery Replacement

### 2.6.1 Battery Replacement Procedure for AA-Cell Sensor Variants

1. There are case-release slots in the front and back of the enclosure near the bottom end-cap. Using pliers or a similar tool, press on each of the case-release tabs until the lips clear the edge and the end-cap is free as shown in Figure 2-5.



**Figure 2-5: Using a Tool to Release the End-Cap**

2. Pull the end-cap out. The end-cap is fastened to the PCBA such that the whole interior of the device will also come out.
3. Remove the battery and replace with a new one. Ensure that the polarity of the battery is in the proper orientation as shown in Figure 2-6.



**Figure 2-6: Battery Polarity Orientation**

4. Replace the PCBA and end-cap in the same orientation as before and push firmly to shut as shown in Figure 2-7.

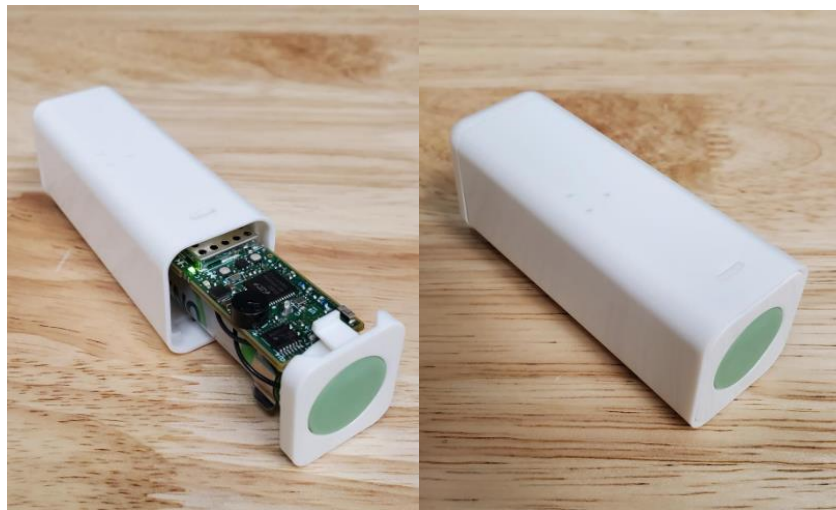

**Figure 2-7: Replacing the PCBA and End-Cap**

## 2.6.2 Battery Replacement Procedure for C-Cell Sensor Variants

The battery cover is marked with a battery symbol and uses Phillips Head H1 screws. This is the cover that needs to be removed to replace the battery, NOT the feature cover on the opposite side which is marked by a magnet symbol and uses Torx Head screws.

1. In a non-hazardous location, remove the battery cover by unscrewing the 4x phillips head screws using a size #1 phillips head screwdriver as shown in Figure 2-8.



Figure 2-8: Removing the Battery Cover Screws

2. Remove and the used battery, and replace it with a new 3.6V XENO XL-145F battery **ONLY**. When inserting the new battery, insert the negative terminal side first. The battery contacts are marked with their proper polarities (see Figure 2-9), with the positive terminal marked with a plus-sign (+), and the negative with a minus-sign (-).

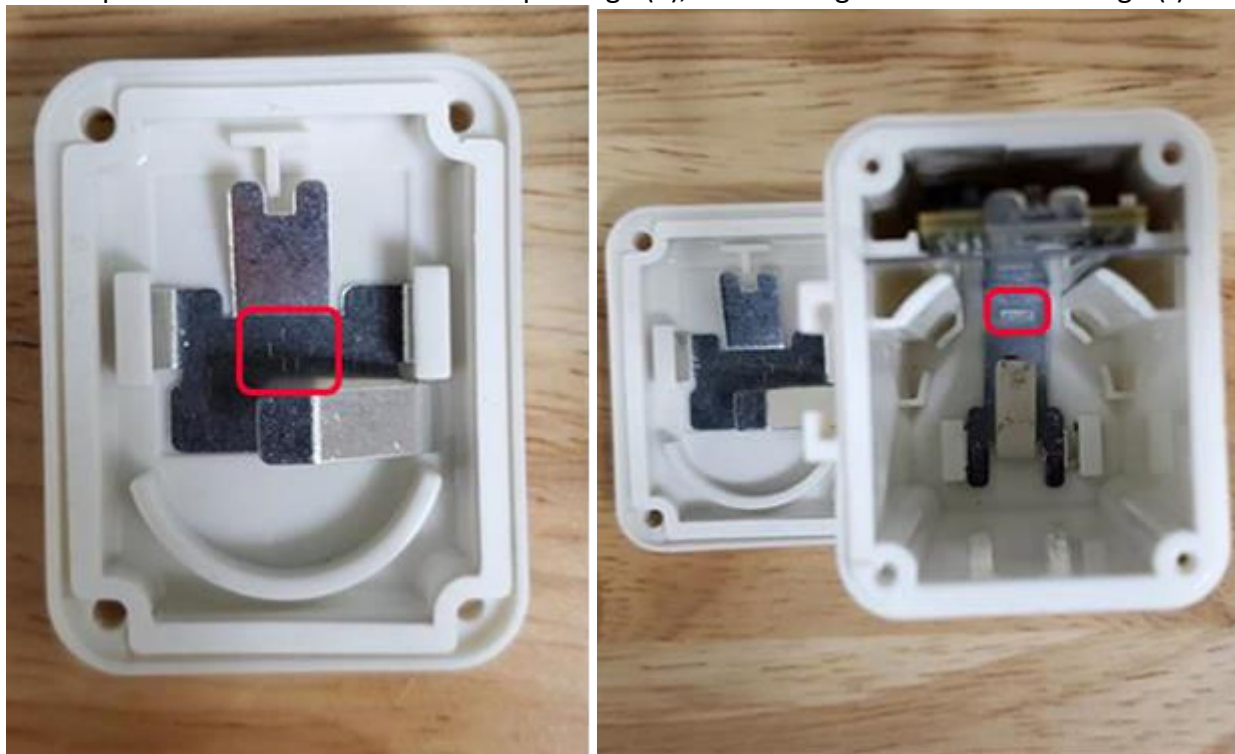





**Figure 2-9: Battery Polarity Markers and Insertion**

3. Check that the gasket is undamaged and still properly seated with an adhesive on the battery cover. It should look similar to Figure 2-10.



**Figure 2-10: Proper Gasket Appearance**

4. Before reattaching the battery cover, ensure the proper orientation of the cover by placing the battery symbol next to the mounting feature. You can also ensure proper orientation by closing it with the semi-circular rib against the battery, and the T-shaped rib against the PCBA (see Figure 2-11).



**Figure 2-11: Proper Replacement Orientation of the Battery Cover**

5. Reassemble the cover to the chassis by using the 4x phillips head screws, using a #1 size screwdriver and up to 0.23 Nm of torque.

## 3 Operation, Alarms, and Management

### 3.1 Configuration

The Gen2 sensor variants support a full range of OTA configuration options. Specific technical details are available in the corresponding TRM document for each functional grouping. All configuration commands need to be sent OTA during the sensor's DL Rx windows.

### 3.2 Default Configuration

Table 3-1 lists the default reporting behaviour for each functional grouping of the Gen2 sensor variants. Reporting behaviour can be changed from default through OTA DL commands.

**Table 3-1: Default Reporting Periods of Functional Groupings**

Reported Data	Enterprise Asset Trackers	SafeAlerts	Contact Tracing Devices	Tundra Sensors
Battery Voltage	24 hours	24 hours	24 hours	1 hour
Discovered BLE devices	1 hour	30 seconds (when button is pressed)	N/A	N/A
Contact Data	N/A	N/A	15 minutes	N/A
Ambient Temperature	N/A	N/A	N/A	1 hour
Relative Humidity	N/A	N/A	N/A	1 hour
Acceleration Vector	Disabled	Disabled	N/A	Disabled
MCU Temperature	Disabled	Disabled	Disabled	Disabled

### 3.3 RF LED Behaviour

See Figure 1-4 for the location and identification of the green and red Sensor RF LEDs. The boot and join LED procedure is as follows.

1. Both LEDs will come on briefly when power is first applied.
2. After a small delay ( $< 1$  s) the LEDs will turn off and one of them will blink briefly.
  - a. If the green system LED blinks, then all health checks on the board passed.
  - b. If the red LoRa LED blinks, then one of the health checks failed. Consider replacing the battery, or moving the sensor to an environment within temperature range.
3. Immediately after the boot pattern, the join procedure will begin. During this time the green system LED will blink continuously until the sensor has joined a network.
4. The red LoRa LED will now blink whenever LoRa activity occurs on the sensor (transmitting or receiving packets, including the join request packets).

During normal operation,

- The red LoRa LED will blink whenever LoRa activity occurs on the sensor (transmitting or receiving packets), and
- The green system LED can be controlled via the downlink command interface.

**NOTE:** Any other LED pattern behaviour not described above most likely indicates a low battery. For example, if steps 1-2 repeat continuously, the battery no longer has enough charge to power the join procedure.

### 3.4 Reset Function

Each Gen2 sensor variant is capable of a physically-triggered reset. This type of reset powers down the MCU and restarts it, causing the network join procedure to begin again.

For all AA-cell variants, there is an externally-accessible function button on the device, that can be pushed by a pin, such as a paper clip (see Figure 1-4). The button should not be pushed hard. For all C-cell variants, the reset is triggered by applying the magnetic pattern as shown in Figure 2-1. While this pattern causes the sensor to wake from deep sleep before activation, during normal operation this pattern causes a reset.

**NOTE:** Shutting down or resetting the sensor will cause all unsaved user configurations to be lost. Save the desired configuration to the sensor flash before powering off or resetting.

### 3.5 Function Button

The Contact Tracing Device, SafeAlert, and, optionally, Enterprise Asset Tracker variants (non-ATEX) variants have an externally-accessible function button located on the bottom of the enclosure. The button is actuated by pushing. Different push patterns can cause different behaviour, depending on the functional type of the sensor. Refer to the specific TRM documents for descriptions of the function button behaviour and user configurability.

### 3.6 Buzzer and Vibration Feedback

The Contact Tracing Device and SafeAlert variants are equipped with a PCBA-mounted buzzer and vibration motor. These provide audible and haptic feedback for the user during normal operation. Refer to the specific TRM documents for descriptions of the buzzer and vibration motor behaviour and user configurability.

## 4 Compliance Statements

### **Federal Communications Commission:**

This device complies with Part 15 of the FCC Rules [5]. Operation is subject to the following two conditions:

1. This device may not cause harmful interference, and
2. This device must accept any interference received, including interference that may cause undesired operation.

To comply with FCC exposure limits for general population / uncontrolled exposure, this device should be installed at a distance of 20 cm from all persons and must not be co-located or operating in conjunction with any other transmitter.

Changes or modifications not expressly approved by the party responsible for compliance could void the user's authority to operate the equipment. This equipment has been tested and found to comply with the limits for a Class B digital device, pursuant to Part 15 of the FCC Rules. These limits are designed to provide reasonable protection against harmful interference in an industrial installation. This equipment generates uses and can radiate radio frequency energy and, if not installed and used in accordance with the instructions, may cause harmful interference to radio communications. However, there is no guarantee that interference will not occur in a particular installation. If this equipment does cause harmful interference to radio or television reception, which can be determined by turning the equipment off and on, the user is encouraged to try to correct the interference by one of the following measures:

- Reorient or relocate the receiving antenna.
- Increase the separation between the equipment and receiver.
- Connect the equipment into an outlet on a circuit different from that to which the receiver is connected.
- Consult the dealer or an experienced radio/TV technician for help.

### **Innovation, Science and Economic Development Canada (Industry Canada):**

This device contains licence-exempt transmitter(s)/receiver(s) that comply with Innovation, Science and Economic Development Canada's licence-exempt RSS(s) [6]. Operation is subject to the following two conditions:

- i. This device may not cause interference, and

- ii. This device must accept any interference, including interference that may cause undesired operation of the device.

This device should be installed and operated with minimum distance 0.2 m from human body.

*L'émetteur/récepteur exempt de licence contenu dans le présent appareil est conforme aux CNR d'Innovation, Sciences et Développement économique Canada applicables aux appareils radio exempts de licence. L'exploitation est autorisée aux deux conditions suivantes:*

*(1) L'appareil ne doit pas produire de brouillage.*

*(2) L'appareil doit accepter tout brouillage radioélectrique subi, même si le brouillage est susceptible d'en compromettre le fonctionnement.*

*Cet appareil doit être installé et utilisé à une distance minimale de 0.2 m du corps humain.*

**California Proposition 65:**

 **WARNING:** This product can expose you to chemicals including lead, nickel, and carbon black, which are known to the State of California to cause cancer, birth defects or other reproductive harm. For more information, go to [www.P65Warnings.ca.gov](http://www.P65Warnings.ca.gov) [7].

## References

- [1] LoRa Alliance, "LoRaWAN™ 1.0.2 Regional Parameters," February 2017. [Online]. Available: [https://lora-alliance.org/wp-content/uploads/2020/11/lorawan\\_regional\\_parameters\\_v1.0.2\\_final\\_1944\\_1.pdf](https://lora-alliance.org/wp-content/uploads/2020/11/lorawan_regional_parameters_v1.0.2_final_1944_1.pdf). [Accessed 12 April 2021].
- [2] Bluetooth SIG, "Bluetooth Core Specifications v 5.0," 6 December 2016. [Online]. Available: <https://www.mouser.it/pdfdocs/bluetooth-Core-v50.pdf>. [Accessed 12 April 2021].
- [3] Tadiran Batteries GmbH, "Tadiran Lithium Batteries: Technical Brochure LTC-Batteries," Tadiran Batteries, Büdingen, Germany, 2020.
- [4] TEKTELIC Communications Inc, "Network Server Quickstart Guide - Creating Your first network," 21 August 2019. [Online]. Available: <https://support.tektelic.com/support/tektelic/ShowHomePage.do?articlestatus=published#Solutions/dv/274696000014617215/en/History>. [Accessed 12 April 2021].
- [5] Office of the Federal Register, "Electronic Code of Federal Regulations: Title 47; Part 15 - Radio Frequency Devices," e-CFR, 28 February 2020. [Online]. Available: [https://www.ecfr.gov/cgi-bin/text-idx?SID=86ed79fc9447ceff183191690a733ec7&mc=true&node=pt47.1.15&rgn=div5#se47.1.15\\_11](https://www.ecfr.gov/cgi-bin/text-idx?SID=86ed79fc9447ceff183191690a733ec7&mc=true&node=pt47.1.15&rgn=div5#se47.1.15_11). [Accessed 3 March 2020].
- [6] Innovation, Science and Economic Development Canada, "RSS-Gen: General Requirements for Compliance of Radio Apparatus; Issue 5; Amendment 1," March 2019. [Online]. Available: [ic.gc.ca/eic/site/smt-gst.nsf/vwapj/RSS-Geni1amend12019-04EN.pdf/\\$FILE/RSS-Geni1amend12019-04EN.pdf](https://ic.gc.ca/eic/site/smt-gst.nsf/vwapj/RSS-Geni1amend12019-04EN.pdf/$FILE/RSS-Geni1amend12019-04EN.pdf). [Accessed 3 March 2020].
- [7] OEHHA, "Proposition 65," California Office of Environmental Health Hazard Assessment, 2020. [Online]. Available: <https://oehha.ca.gov/proposition-65>. [Accessed 3 March 2020].
- [8] Saft, Specialty Battery Group, "Primary lithium battery: LS 14500," Saft, September 2009. [Online]. Available: <https://datasheet.octopart.com/LS14500-Saft-datasheet-15505441.pdf>. [Accessed 3 March 2020].
- [9] Tadiran Batteries, "Model TL-4903 Technical Data," January 2007. [Online]. Available: <https://datasheet.octopart.com/TL-4903/S-Tadiran-datasheet-556727.pdf>. [Accessed 3 March 2020].
- [10] Tadiran Batteries GmbH, "LTC Batteries: SL-360," January 2012. [Online]. Available: <https://datasheet.octopart.com/SL-360-S-Tadiran-datasheet-128477996.pdf>. [Accessed 21 February 2020].
- [11] Tadiran Battery Group, "Model TL-5903 Technical Data," November 2011. [Online]. Available: <https://datasheet.octopart.com/TL-5903/S-Tadiran-datasheet-8817806.pdf>. [Accessed 3 March 2020].
- [12] Xeno Energy Co. Ltd., "XL-060F Specifications," 2010. [Online]. Available: [http://www.xenoenergy.com/eng/file/Xeno%20Catalog%20XL-060F\\_E.pdf](http://www.xenoenergy.com/eng/file/Xeno%20Catalog%20XL-060F_E.pdf). [Accessed 3 March 2020].
- [13] TEKTELIC Communications Inc., "BLE Asset Tracker: Technical Reference Manual T0005946\_TRM\_v0.4," TEKTELIC Communications Inc., Calgary, 2019.
- [14] TEKTELIC Communications, Inc., *BLE ASSET Tracker Quick Start Guide T0005946\_QSG\_ver1.0*, Calgary, 2020.



