



TEKTELIC Communications Inc.
7657 10th Street NE Calgary, Alberta
Canada, T2E 8X2

KIWI/CLOVER AGRICULTURE SENSOR

User Guide

Document Type:	User Guide
Document Number:	T0005978_UG
Document Issue:	2.1
Document Status:	Release
Product Name:	KIWI/CLOVER Agricultural Sensor
Product Code:	T0005982 (Agricultural Sensor, CLOVER Module, LoRa) T0005986 (Agriculture Sensor, KIWI Module, LoRa)
Issue Date:	November 16, 2023

PROPRIETARY:

The information contained in this document is the property of TEKTELIC Communications Inc. Except as specifically authorized in writing by TEKTELIC, the holder of this document shall keep all information contained herein confidential, and shall protect the same in whole or in part from disclosure to all third parties.

© 2023 TEKTELIC Communications Inc., all rights reserved.

All products, names, and services are trademarks and registered trademarks of their respective companies.

TEKTELIC Communications Inc.
7657 10th Street NE
Calgary, AB, Canada T2E 8X2
Phone: (403) 338-6900

Document Revision

Revision	Issue Date	Status	Editor	Comments
0.1	June 4, 2019	Initial Draft	Emma Tholl	First draft.
0.2	January 28, 2020	Draft	Mark Oevering	Numerous updates Updated part numbers in Table 1.
0.3	April 6, 2020	Release candidate	Mark Oevering	Updated document to new template. Update to Compliance statement.
1.0	April 16, 2020	Release	Mark Oevering	Changes to naming convention for modules.
1.1	April 16, 2020	Release	Conor Karperien	Updated table for default configuration.
1.2	April 20, 2020	Release	Mark Oevering	Added note about using the sensor in direct sunlight. Changed default configuration in Tables 3 & 4 as a result. Added more detail about how soil moisture is measured between the two modules.
1.3	May 14, 2020	Release	Mark Oevering	Refined statement about direct sunlight in overview section. Change to magnetic wake-up pattern.
1.4	May 27, 2020	Release	Zenon Herasymiuk	Added battery polarity statement on Section 1.3
1.5	July 7, 2020	Release	Mark Oevering	Added Watermark information in Overview section
1.6	July 22, 2020	Release	Mark Oevering	Clarifications to table for Figure 3, Page 9
1.7	September 28, 2020	Release	Mark Oevering	Added note regarding tape over battery for early versions of the Agriculture Sensor
1.8	December 16, 2020	Release	Mark Oevering	Corrections to Table 2
1.9	April 5, 2021	Release	Mark Oevering	Added ALS range to Table 2
2.0	May 05, 2023	Release	Adedolapo Adegboye	Added Note on input 3 and 4 switches and possible delay after first wake up

2.1	16 November 2023	Release	Adedolapo Adegboye	Added disclaimer note in section 2.1 regarding activation magnet
-----	------------------	---------	--------------------	--

Table of Contents

1	Product Description	7
1.1	Overview	7
1.2	Physical Interfaces – KIWI Only	11
1.2.1	Analog Thermistors – Inputs 3 and 4	12
1.2.2	Onewire probes - Inputs 3 and 4	13
1.2.3	Watermark Probes - Inputs 5 and 6.....	14
1.3	Specifications.....	15
2	Installation	17
2.1	Included Product and Installation Material	17
2.2	Safety Precautions.....	17
2.3	Unpacking and Inspection	17
2.4	Equipment Required for Installation.....	17
2.5	KIWI Sensor Mounting	18
2.6	Cable Installation.....	18
3	Power Up, Commissioning and Monitoring	20
3.1	Reed Switch Awakening Procedure	20
3.2	Commissioning	22
4	Battery Replacement.....	23
5	Operation, Alarms, and Management.....	24
5.1	Configuration.....	24
5.2	Default Configuration.....	24
5.3	LED Behaviour	24
6	Compliance Statements.....	26
7	Bibliography.....	28

List of Tables

Table 1: Agriculture LoRa IoT Sensor Models	7
Table 2: Analog thermistor supported by KIWI variant.....	12
Table 3: Wiring and Switching Information for Thermistor Connection	12
Table 4: Digital onewire temperature probe supported by KIWI variant.	13
Table 5: Wiring and Switching Information for Onewire Connection	13
Table 6: Supported Watermark Probes for KIWI variant.....	14
Table 7: Wiring Information for Watermark Connection	14
Table 8: Agriculture Sensor Specifications.....	15
Table 9: Default Configuration - CLOVER.....	24
Table 10: Default Configuration - KIWI.....	24

List of Figures

Figure 1: CLOVER Module - Exterior view.....	9
Figure 2: CLOVER Module – interior view.....	9
Figure 3: The Agricultural Sensor KIWI model - External view	10
Figure 4: The Agricultural Sensor KIWI model - Internal View	10
Figure 5: KIWI connector block for connecting external probes.	11
Figure 6: Input 3 and 4 Switches showing “SW4” and “SW5” default positions.....	11
Figure 7: Structural diagram of the TT02-10KC8-T105-1500 [3]	12
Figure 8: One-wire Temperature Probe [4]	13
Figure 9: Watermark Sensors [5]	14
Figure 10: KIWI model showing the mounting holes.....	18
Figure 11: Reed switch location	20
Figure 12: Agriculture Sensor magnetic reset/wake-up pattern.....	21
Figure 13: Agriculture Sensor magnetic UL-triggering pattern	22
Figure 14: LED Location.....	25

1 Product Description

1.1 Overview

The Agricultural Sensor, henceforth referred to as “Sensor”, is a multi-purpose LoRaWAN IoT sensor intended for Agricultural use. The “KIWI” model supports the connection of up to four analog and two digital probe inputs, allowing for remote capture of data. The “CLOVER” model includes two integrated metal probes for contact measurement of soil data. Table 1 presents the Agriculture Sensor models and their corresponding RF information.

Table 1: Agriculture LoRa IoT Sensor Models

Product Code & Revision	Description	RF Region	Tx Band (MHz)	Rx Band (MHz)
T0005986	AGRICULTURE SENSOR, KIWI MODULE	US 902-928 MHz (ISM Band) EU 863-870 MHz (ISM Band)	923-928 863-870	902-915 863-870
T0005982	AGRICULTURE SENSOR, SOIL CLOVER MODULE	US 902-928 MHz (ISM Band) EU 863-870 MHz (ISM Band)	923-928 863-870	902-915 863-870

The main features of the Agricultural Sensor are as listed below:

- **Temperature & Relative Humidity Sensor:** Reports temperature and relative humidity of the ambient environment.

PLEASE NOTE: PLACING THE UNIT IN DIRECT SUNLIGHT WILL RESULT IN THE SENSOR REPORTING CASE TEMPERATURE AND RELATIVE HUMIDITY INSTEAD OF TRUE AMBIENT CONDITIONS. PLACE THE UNIT OUT OF THE SUN FOR MORE ACCURATE AMBIENT TEMPERATURE AND RELATIVE HUMIDITY READINGS.

- **Accelerometer:** High sensitivity device that can measure any shock or movement events. The primary purpose is to detect orientation change and report orientation alarm
- **Light Sensor:** reports the ambient light intensity measured in units of lux.

- **Current Sense:** provides accurate battery life estimation in percentage and days remaining.
- **Analog thermistor and One wire probe – KIWI only:** Option to measure temperature using external probes interfaced with the sensor.
- **Watermark Sensor – KIWI only:** Option to receive data on soil water tension. The Watermark is a resistive device that responds to changes in soil moisture. Once planted in the soil, it exchanges water with the surrounding soil thus staying in equilibrium. Soil water is an electrical conductor thereby providing a relative indication of the soil moisture status. As the soil dries, water is removed from the sensor and the resistance measurement increases. Conversely, when the soil is rewetted, the resistance lowers. The relationship of ohms of resistance to centibars (cb) or kilopascals (kPa) of soil water tension is constant.

The Watermark is calibrated to report soil water tension or matric potential, which is the best reference of how readily available soil water is to a plant. The raw data reported by the sensor for the watermarks is a frequency that increases as the watermark gets more saturated. Please refer to the TRM (TEKTELIC communications Inc, 2023) for information on how to convert the frequency to Soil Water Tension.

Note: The Watermark sensors need to be installed wet. If time permits, slowly wet the sensor by partially submerging in a glass of water (no more than halfway) for 30 minutes in the morning and let dry until evening, wet for 30 minutes, let dry overnight, wet again for 30 minutes the next morning and let dry until evening. Soak over the next night and install WET. Following this first-time installation guide will improve the sensor response in the first few irrigations (Irrrometer).

There are several things to note regarding installation depending on the use case for the Watermark sensor. Please review the installation and operations instructions in *701 Meter Manual-WEB.pdf file* (Irrrometer) in knowledge Base of the Tektelic Support Portal.

- **CLOVER Probe – CLOVER only:** Option to measure soil moisture content and temperature. The probes work in a similar manner to the Watermark Sensor described above. There is no exchange of water with the surrounding soil. However, the probes simply measure how saturated and warm or cold the soil is and provides a frequency reading. Please refer to the TRM for information on how to convert the frequency to Gravimetric Water Content.
- **MCU Temperature:** Reports temperature of the MCU.

An illustration of the CLOVER Sensor in the enclosure can be seen in Figure 1 and Figure 2 below. The CLOVER Sensor houses two PCBA's which provide all the functionality required by the product.

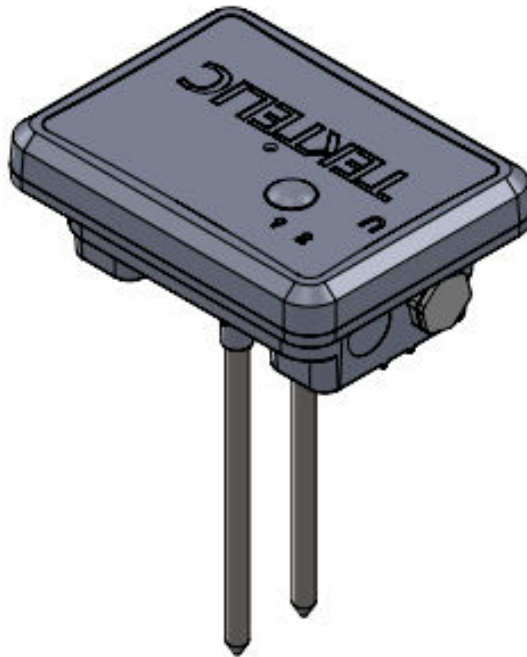

Figure 1: CLOVER Module - Exterior view

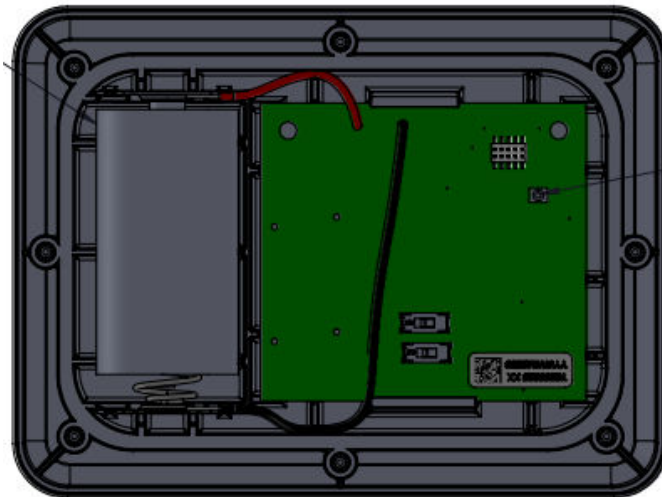

Figure 2: CLOVER Module – interior view

An illustration of the KIWI Sensor in the enclosure can be seen in Figure 3 and Figure 4 below. The KIWI Sensor houses one PCBA which provides all the functionality required by the product.

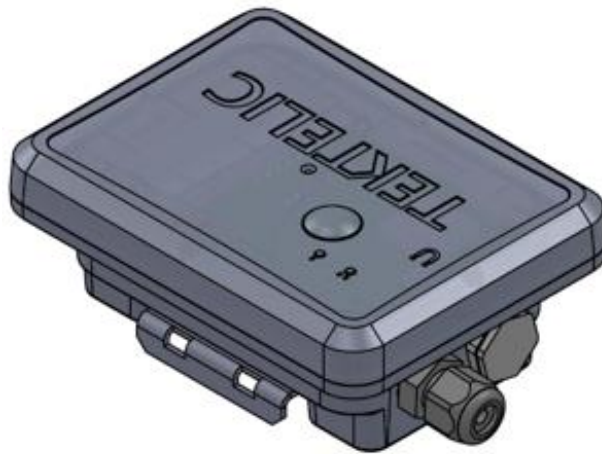

Figure 3: The Agricultural Sensor KIWI model - External view

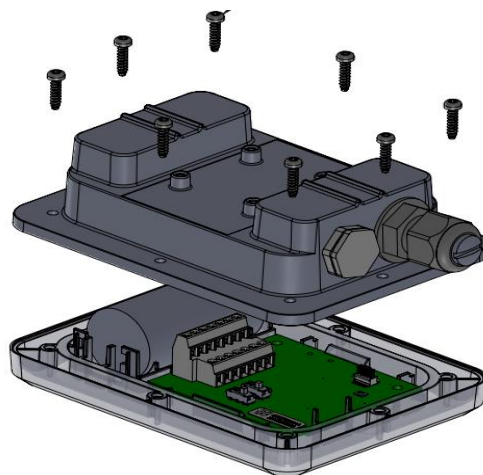

Figure 4: The Agricultural Sensor KIWI model - Internal View

The enclosure, measured at 120 mm x 90 mm x 58 mm (H=161mm with probes) for the CLOVER model and 120 mm x 90 mm x 47 mm for the KIWI model, is a custom design by Tektelic. It is a water-tight enclosure that is modified to add a humidity vent, as well as a water-tight cable gland for connection to external transducers.

The case is opened by removing the eight Phillips screws in the bottom of the enclosure and opening the lid allowing access to the power and input terminals.

The battery holder is adhered to the inside of the case lid and is a standard C-cell holder for an LTC battery. Replacement of the battery is accomplished by opening the lid as described above, replacing the cell in the holder, and securing the lid to the enclosure again.

1.2 Physical Interfaces – KIWI Only

Figure 5 below illustrates the customer accessible interfaces for the KIWI Sensor.

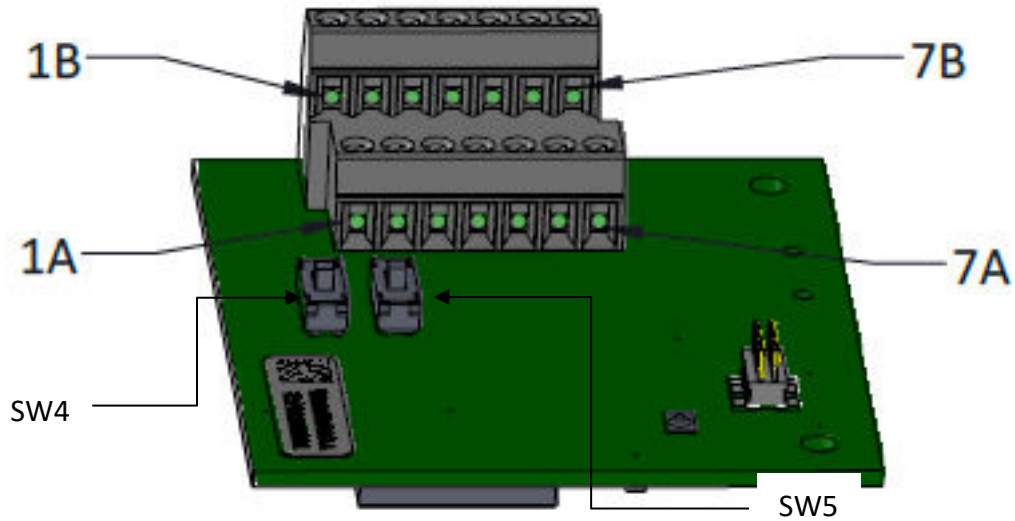

Figure 5: KIWI connector block for connecting external probes.

Legend:

1A = Input 2+ (**RES**)

2A = Input 2-

3A = Input 3 (Thermistor 1) *

4A = Input 3 (Thermistor 1) *

5A = Input 4 (Thermistor 2) *

6A = Input 4 (Thermistor 2) *

7A = GND

SW4 = Switch for Input 3¹

RES = Reserved pins for CLOVER Module Only

1B = Input 1+ (**RES**)

2B = Input 1-

3B = Moisture 1 (Watermark 1) *

4B = Moisture 1 (Watermark 1) *

5B = Moisture 2 (Watermark 2) *

6B = Moisture 2 (Watermark 2) *

7B = Power (**RES**)

SW5 = Switch for Input 4¹

Figure 6: Input 3 and 4 Switches showing “SW4” and “SW5” default positions



¹ SW4 and SW5 are not supported in HW revision lower than F0

1.2.1 Analog Thermistors – Inputs 3 and 4

The KIWI sensor supports the connection of up to two analog thermistor probes at the same time. Table 2 below shows the only type of analog thermistor supported by the KIWI variant.

Table 2: Analog thermistor supported by KIWI variant.

Probe type	Part Number	Product T-code
Analog thermistor	TT02-10KC8-T105-1500	T0006993

Analog thermistor probes can be used for temperature measurement by connecting the thermistor’s connectors to input 3 and input 4. Table 3 below provide the interface wiring and switch positions for all possible thermistor connections to the KIWI.

Table 3: Wiring and Switching Information for Thermistor Connection

Input	Interface Wiring			Required Switches Position ²	
	Wire Color	Polarity	Terminal Block Pin	SW4	SW5
3 only	White	POSITIVE	3A	“THERM” position	“THERM” position
	Black	NEGATIVE	4A		
4 only	White	POSITIVE	5A	“THERM” position	“THERM” position
	Black	NEGATIVE	6A		
3 and 4	White	POSITIVE	3A, 5A	“THERM” position	“THERM” position
	Black	NEGATIVE	4A, 6A		

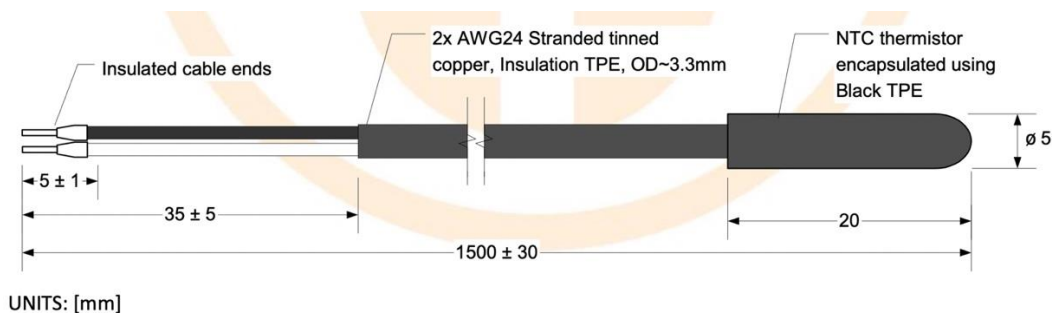

Figure 7: Structural diagram of the TT02-10KC8-T105-1500 (TEWA Temperature Sensors, 2015)

² The switches are in the “Therm” position by default

1.2.2 Onewire probes - Inputs 3 and 4³

The KIWI sensor supports the connection of up to two digital Onewire probes at the same time. below shows the supported digital onewire probe. Table 4 below shows the onewire probe supported by the KIWI variant.

Table 4: Digital onewire temperature probe supported by KIWI variant.

Probe type	Part Number	Product T-code
Digital Onewire	DFR0198	T0008632

By connecting these probes to input 3 or input 4 and switching the corresponding switches to the required position as shown in Table 5 below, the KIWI sensor can measure and report temperature values.

Table 5: Wiring and Switching Information for Onewire Connection

Input	Interface Wiring			Required Switches Positions	
	Wire Color	Polarity	Terminal Block Pin	SW5	SW6
3 only	Yellow	DATA	3A	"1-WIRE" position	"THERM" position
	Red	POWER	7B		
	Black/Blue	GROUND	7A		
4 only	Yellow	DATA	5A	"THERM" position	"1-WIRE" position
	Red	POWER	7B		
	Black/Blue	GROUND	7A		
3 and 4	Yellow	DATA	3A, 5A	"1-WIRE" position	"1-WIRE" position
	Red	POWER	7B		
	Black/Blue	GROUND	7A		



Figure 8: One-wire Temperature Probe (DFRobot, n.d.)

³ Only supported on SW version 1.0.0 and above and HW revision F0 and above

1.2.3 Watermark Probes - Inputs 5 and 6

The KIWI sensor supports the connection of up to two watermark sensors for soil tension measurement.

Table 6: Supported Watermark Probes for KIWI variant

Probe type	Part Number	Product T-code
Watermark	200SS-5	T0005013

The following wiring arrangement in Table 7 should be followed when connecting the watermark probes.

Table 7: Wiring Information for Watermark Connection

Input	Interface Wiring		
	Wire Color	Polarity	Terminal Block Pin
5	GREEN	POSITIVE	3B
	GREEN/WHITE	NEGATIVE	4B
6	GREEN	POSITIVE	5B
	GREEN/WHITE	NEGATIVE	6B

Note: Unlike the temperature probes in Sections 1.2.1 and 1.2.2 above, the watermark sensors do not require any form of switching for operation. This is because watermark probes were not designed to share interfaces with any other probe types.

Note: A sensor restart is required after any probe installation.



Figure 9: Watermark Sensors (Irrrometer, n.d.)

1.3 Specifications

The Agriculture Sensor specifications are listed in Table 8 below.

Table 8: Agriculture Sensor Specifications

Attribute	Specification
Use Environment	Indoor, Outdoor
Environmental Rating	IP67
Operating Temperature	-20°C to 60°C
Storage Temperature for Optimal Battery Life	-40°C to 75°C
Operating Relative Humidity	0%–100%, condensing
Storage Relative Humidity	0%–100%, condensing
Size	CLOVER Sensor: 120 mm x 90 mm x 58 mm (H=161mm with probes) KIWI Sensor: 120 mm x 90 mm x 47 mm
Weight	Soil CLOVER Sensor: 224g KIWI Sensor: 220g (233g with mounting plate)
Power Source	Battery powered: 1x C-cell Lithium Thionyl Chloride (LTC) 3.6V NOTE: If replacing the battery, please ensure it is inserted with the correct polarity.
Network technology/Frequency band	LoRaWAN in multiple variants (see Table 1): US 902-928 MHz, EU 863-870 MHz
Air Interface	LoRa
Battery Lifetime	At least 10 years with a baseline use case: transmission at maximum power every 15 minutes at room temperature
Maximum Tx Power	22 dBm
LED	Green: Joining the network activity Red: LoRa TX or RX activity
Sensing Functions	ambient temperature, ambient humidity, ambient light, accelerometer, battery level, water tension, soil moisture, soil temperature, MCU temperature
Ambient Temperature	±0.2°C within temperature measurement range of -40°C to 125°C*

Attribute	Specification
	Resolution: 0.1°C
Relative Humidity	±2% RH within temperature measurement range of -0%–100%, condensing* Resolution: 0.1%
Ambient Light Intensity	0 to 65,535 lux Resolution: 1 lux
MCU Temperature	±5°C within temperature measurement range of -40°C to 85°C* Resolution: 1°C
Soil Moisture, Input 1⁴	±1 kHz between 1322 kHz – 1402 kHz (120% GWC – 0% GWC) Resolution: 1 kHz, 10% GWC
Soil Temperature, Input 2⁴	±2°C within -15°C and +60°C Resolution: 0.1°C
Input 3 & 4 as thermistor⁵	±2°C within -15°C and +60°C Resolution: 0.1°C
Input 3 & 4 as onewire^{5*}	±0.5°C within -10°C and +85°C Resolution: 0.1°C
Watermark (Input 5 & 6)^{5*}	±1kPa within 0 to 239 kPa Resolution: 1 kPa

⁴ Applicable to CLOVER only

⁵ Applicable to KIWI only

*From the manufacturer datasheet.

2 Installation

2.1 Included Product and Installation Material

The following items are shipped with each sensor:

- LoRa IoT Agriculture Sensor
- LTC C-cell battery installed in the sensor

NOTE: A magnet is required to wake up the sensor from state of DEEP SLEEP the sensor is shipped in. TEKTELIC does **NOT** provide this magnet in the sensor packaging.

2.2 Safety Precautions

The following safety precautions should be observed:

- The Agriculture Sensor is not a toy, PLEASE KEEP AWAY FROM CHILDREN.
- Use only the specified Lithium Thionyl Chloride (LTC) C-cell batteries.
- Do not exceed the maximum specified terminal voltages.
- All installation practices must be in accordance with the local and national electrical codes.
- Sensor inputs do not provide electrical isolation between each other.

2.3 Unpacking and Inspection

The following should be considered during the unpacking of a new Agriculture Sensor:

- Inspect the shipping carton and report any significant damage to TEKTELIC.
- Unpacking should be conducted in a clean and dry location.
- Do not discard the shipping box or inserts as they will be required if a unit is returned for repair or re-configuration.

2.4 Equipment Required for Installation

The following tools are required to install the Agriculture Sensor:

- Torx T10 screwdriver (8 x enclosure screws)
- Slotted screwdriver (internal terminal block connections)
- Wire Stripper
- Wire Cutter

2.5 KIWI Sensor Mounting

On the KIWI model of the Agriculture Sensor, there is a mounting bracket on the bottom of the unit as seen in Figure 10. These mounting holes can be used to screw the enclosure to a solid surface. The recommended mounting screw size is M3 or #6. Mounting screws are not provided with the sensor.

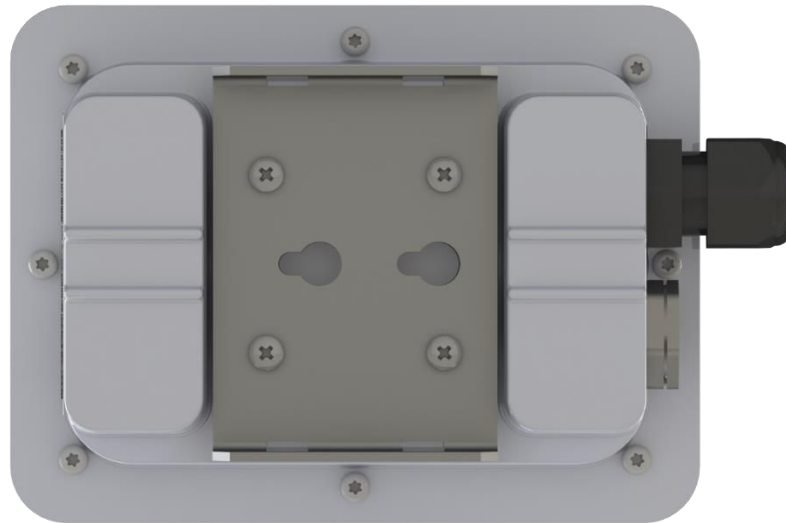

Figure 10: KIWI model showing the mounting holes.

The mounting surface must be capable of holding > 2 kg [4.5 lbs]. Clearance must be provided for the modules cable gland and input cable.

2.6 Cable Installation

The KIWI Sensor enclosure is provided with a waterproof cable gland through which all connections must be routed. The supplied cable gland size is PG-9. This gland supports cables with a jacket outside diameter of 2.67 mm to 8 mm (0.105" to 0.315").

The I/O terminal blocks accept 30-16 AWG wire. Select a cable that meets the application requirements and local and national electrical codes.

Figure 5 shows the terminal block wiring connections. To install the cable, first make the appropriate connections between the input cable and the terminal block. Next, dress the internal wires so that the cable gland seals against the outer cable jacket. Finally, tighten the cable gland.

See Table 3 and Table 5 for input connections. Signal connections should be connected to the positive terminal (labeled '+'). Similarly, the return path should be connected to the negative terminal (labeled '-') of the matching I/O channel.

NOTE: KIWI Sensor I/O are referenced to the sensor ground and are not isolated.

3 Power Up, Commissioning and Monitoring

3.1 Reed Switch Awakening Procedure

Note: Early versions of the Agriculture Sensor were shipped with tape over the positive terminal of the battery. Therefore, if the wakeup pattern described below doesn't work, the battery should be checked, and tape removed if necessary.

The Agriculture Sensor is equipped with a magnetic reed switch. The reed switch can be operated by the provided magnet, and is used for the following purposes:

- 1) MCU reset upon observing a specified magnetic pattern:

This is mainly used to wake up the module from DEEP SLEEP and having it try to join the network. When the module comes out of the factory, it is in the DEEP SLEEP mode,⁶ and can be activated using the specified magnetic pattern. Also, the same magnetic pattern can just be used to reset the Agriculture Sensor during normal operation, getting it to try to rejoin the network.

The magnetic pattern in this application is hard coded (not user configurable) as illustrated in Figure 12. A magnet presence is achieved by positioning the magnet onto the enclosure at the magnet sign. A magnet absence is achieved by taking the magnet away from the enclosure. The magnet sign is illustrated in Figure 11 below:

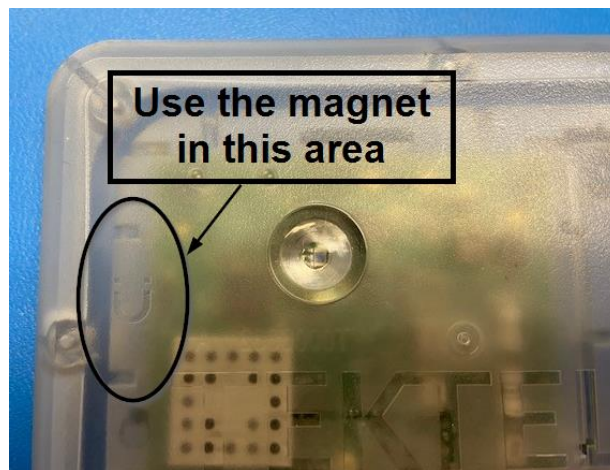

Figure 11: Reed switch location

⁶ The Agriculture Sensor will go to DEEP SLEEP whenever the internal sleep button on the PCBA (labeled SW1) is pressed. This is performed as the last step in the factory before closing the enclosure. The only ways to activate the module out of DEEP SLEEP is to apply the specified magnetic pattern or to open the enclosure and remove and reinsert the battery.

Here are the steps as illustrated in Figure 12:

1. Attach the magnet to the enclosure at the magnet sign, and hold it for at least 3 sec but less than 10 sec.
2. Keep the magnet away for at least 3 sec.

As soon as the specified magnetic pattern is applied to the Agriculture Sensor, the Agriculture Sensor is reset and tries to join the network. It may take about 10 sec from the Agriculture Sensor reset to seeing the LED activity showing join attempts. Therefore, as step 1 in the above is completed, it takes about 13 seconds before observing the LED activity (if step 2 is respected).

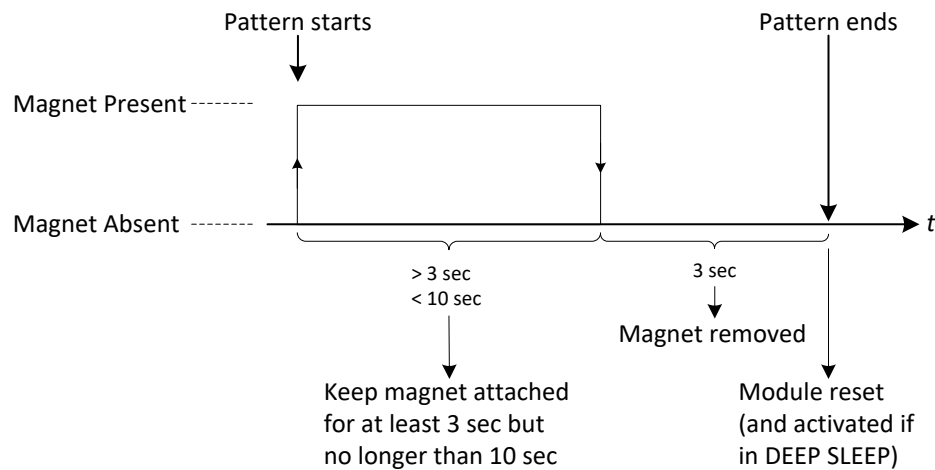

Figure 12: Agriculture Sensor magnetic reset/wake-up pattern

Note 2: The sensor may take a few minutes to join the network for the first time after waking up from DEEP SLEEP. This is due to the new battery firing up for the first time. This delay should not exceed 10 minutes.

- 2) Triggering the Agriculture Sensor to uplink something upon observing a magnetic pattern:

This is used to get the LoRaWAN Class-A Agriculture Sensor to open a receive window so it can receive DL commands from the NS, or simply to trigger the Agriculture Sensor to uplink some desired transducer data.

The magnetic pattern in this case is not user configurable and involves attaching and taking away the magnet to and from the magnet sign at the top of the enclosure once, all in less than 2 sec, as shown in Figure 13. It is important to note here that mistakenly holding the magnet attached to the module for more than 3 sec may trigger a module reset, as explained in item 1 above.

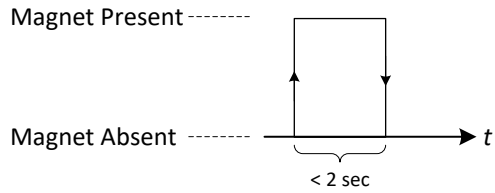

Figure 13: Agriculture Sensor magnetic UL-triggering pattern

Note: Replacing the batteries of the Agriculture Sensor does not cause the Agriculture Sensor to go to DEEP SLEEP. As soon as a new battery is inserted, the Agriculture Sensor boots up and tries to join a LoRaWAN network.

3.2 Commissioning

To add your sensor to the Network Server, you will need to enter the DevEUI, AppEUI and AppKey that were provided for your device from Tektelic.

4 Battery Replacement

Open up the Agriculture Sensor using a #10 Torx screwdriver. The Agriculture Sensor has 8x enclosure Torx screws at the bottom. Be careful not to misplace the silicone cover gasket from the top lid.

Replace the battery. The Agriculture Sensor accepts C-size, 3.6 V, LTC batteries. The allowed replacement batteries are as follows:

- Xeno Energy, part number: XL-145F
- Tadiran Battery, part number TL-4920/S
- Tadiran Battery, part number TL-5920/S

Once the Agriculture Sensor is powered and tries to join (see Section 5.3 for LED behavior), replace the cover and gasket. Make sure that the gasket is properly seated in the cover before placing on the Agriculture Sensor housing. Tighten the 8 cover screws to 2.5 lbf-in (30 N-cm).

5 Operation, Alarms, and Management

5.1 Configuration

The Agriculture Sensor supports a full range of Over-the-Air (OTA) configuration options. Specific technical details are available in the Agriculture Sensor Technical Reference Manual. All configuration commands need to be sent OTA during a sensor's downlink windows.

5.2 Default Configuration

The default configuration of the **CLOVER** Sensor for reporting transducer readings includes the following:

Table 9: Default Configuration - CLOVER

Parameter	Value
Seconds per Core Tick	900 (15 min)
Ticks per battery voltage measurement	96 (24-hours)
Ticks per Ambient Temperature	1 (15 min)
Ticks per Ambient Relative Humidity	1 (15 min)
Ticks per Soil Moisture	1 (15 min)
Ticks per Soil Temperature	1 (15 min)
Ticks per Ambient Light	1 (15 min)

The default configuration of the **KIWI** Sensor for reporting transducer readings includes the following:

Table 10: Default Configuration - KIWI

Parameter	Value
Seconds per Core Tick	900 (15 min)
Ticks per battery voltage measurement	96 (24-hours)
Ticks per Watermark 1	1 (15 min)
Ticks per Watermark 2	1 (15 min)
Ticks per Ambient Light	1 (15 min)

5.3 LED Behaviour

The LEDs are located on the top of the Agricultural Sensor. See Figure 14 below for a photo of LED location.

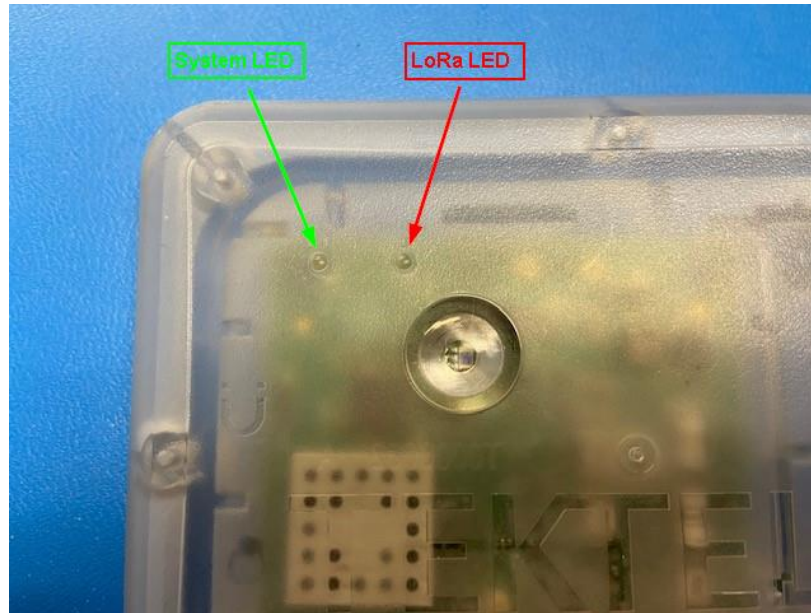

Figure 14: LED Location

During the boot and join procedure:

- Both LEDs will come on briefly when power is first applied.
- After a small delay (< 1 second) the LEDs will turn off and one of them will blink briefly.
 - If the System (green) LED blinks, then all health checks on the board have passed.
 - If the LoRa LED (red) blinks, then one of the health checks has failed. Consider replacing the battery, or moving the sensor to an environment within the temperature range.
- Immediately after the delay, the join procedure will begin. During the time the System LED will blink continuously until the sensor joins a network.
- Note that the device may take longer to join for the first wake up from deep sleep
- The LoRa LED will now blink whenever LoRa activity occurs on the sensor (transmitting or receiving packets).

During normal operation:

- The LoRa LED will blink whenever LoRa activity occurs on the sensor (transmitting or receiving packets)
- The System LED can be controlled via the downlink command interface.

6 Compliance Statements

Federal Communications Commission

This device complies with Part 15 of the FCC Rules. Operation is subject to the following two conditions:

1. This device may not cause harmful interference, and
2. This device must accept any interference received, including interference that may cause undesired operation.

To comply with FCC exposure limits for general population / uncontrolled exposure, this device should be installed at a distance of 20 cm from all persons and must not be co-located or operating in conjunction with any other transmitter.

Changes or modifications not expressly approved by the party responsible for compliance could void the user's authority to operate the equipment. This equipment has been tested and found to comply with the limits for a Class A digital device, pursuant to Part 15 of the FCC Rules. These limits are designed to provide reasonable protection against harmful interference in an industrial installation. This equipment generates uses and can radiate radio frequency energy and, if not installed and used in accordance with the instructions, may cause harmful interference to radio communications. However, there is no guarantee that interference will not occur in a particular installation. If this equipment does cause harmful interference to radio or television reception, which can be determined by turning the equipment off and on, the user is encouraged to try to correct the interference by one of the following measures:

- Reorient or relocate the receiving antenna.
- Increase the separation between the equipment and receiver.
- Connect the equipment into an outlet on a circuit different from that to which the receiver is connected.
- Consult the dealer or an experienced radio/TV technician for help.

Innovation, Science and Economic Development Canada:

This device contains license-exempt transmitter(s)/receiver(s) that comply with Innovation, Science and Economic Development Canada's license-exempt RSS(s). Operation is subject to the following two conditions:

- (1) This device may not cause interference.
- (2) This device must accept any interference, including interference that may cause undesired operation of the device.

This device should be installed and operated with minimum distance 0.2 m from human body.

L'émetteur/récepteur exempt de licence contenu dans le présent appareil est conforme aux CNR d'Innovation, Sciences et Développement économique Canada applicables aux appareils radio exempts de licence. L'exploitation est autorisée aux deux conditions suivantes :

- a. L'appareil ne doit pas produire de brouillage.
- b. L'appareil doit accepter tout brouillage radioélectrique subi, même si le brouillage est susceptible d'en compromettre le fonctionnement.

Cet appareil doit être installé et utilisé à une distance minimale de 0.2 m du corps humain.

Proposition 65

 **WARNING:** This product can expose you to chemicals including lead, nickel & carbon black, which is known to the State of California to cause cancer, birth defects or other reproductive harm. For more information, go to www.P65Warnings.ca.gov.

7 Bibliography

DFRobot. (n.d.). *Waterproof DS18B20 Digital Temperature Sensor for Arduino*. (DFRobot)
Retrieved 05 05, 2023, from
https://media.digikey.com/pdf/Data%20Sheets/DFRobot%20PDFs/DFR0198_Web.pdf

Irrrometer. (n.d.). *701 Meter Manual-WEB.pdf*. CA.: Irrigation Association.

Irrrometer. (n.d.). *Soil Moisture Sensors*. (Irrrometer) Retrieved 05 05, 2023, from
<https://www.irrometer.com/sensors.html#wm>

TEKTELIC communications Inc. (2023). *T0005978_TRM_KIWI_CLOVER_ver1.9*. Calgary: TEKTELIC Communications Inc.

TEWA Temperature Sensors. (2015, 09 24). *Specification of Temperature Probe*. (TEWA)
Retrieved May 05, 2023, from
<https://media.digikey.com/pdf/Data%20Sheets/TEWA/TT02-10KC8-T105-1500.pdf>